

HIOKI

2008 - 2009

Electrical Measuring Instruments General Catalog

Recorders



Power



Electronic



Field



ISO14001
JQA-E-90091



ISO 9001
JMI-0216

www.hioki.com

About the Catalog

Searching for product pages and notes ...

Products in this catalog are grouped according to functions so you can easily find the right instrument for your application by referring to the list of product groups in the table of contents on the first page, and moving directly to the indicated section.

Dimensions and mass:

Exterior dimensions exclude protrusions, and are given in order of width(W), height(H), and depth(D), in mm units. Indicated weight represents an approximation of the mass of the main unit only, not including case, accessories, etc.



ISO 14001

CERTIFICATE No. JQA-E-90081

HIOKI is certified under the international standard ISO 14001 for environmental management systems.



ISO 9001

CERTIFICATE No. JMI-0216

HIOKI's product has been manufactured in conformity with the ISO 9001 international standard on Quality Control and Quality Assurance.

About the marks ...



New products in the 2007 Electrical Measuring Instruments GENERAL CATALOG.



True RMS measuring capability for accurate measurement of even distorted waveforms.

LAN / **GP-IB** / **RS-232C** / **SCSI** / **FAX/modem** / **USB_{1.1}** / **USB_{2.0}**

Models are available with interfaces compatible with LAN, GP-IB, RS-232C, SCSI, FAX/modem and USB standards.

Measurement categories (Overvoltage categories)

To ensure safe operation of measurement products, IEC 61010 establishes safety standards for various electrical environments, categorized as CAT I to CAT IV, and called measurement categories. These are defined as follows.

- CAT I** : Secondary electrical circuits connected to an AC electrical outlet through a transformer or similar device.
- CAT II** : Primary electrical circuits in equipment connected to an AC electrical outlet by a power cord (portable tools, household appliances, etc.)
- CAT III** : Primary electrical circuits of heavy equipment (fixed installations) connected directly to the distribution panel, and feeders from the distribution panel to outlets.
- CAT IV** : The circuit from the service drop to the service entrance, and to the power meter and primary overcurrent protection device (distribution panel).

Higher-numbered categories correspond to electrical environments with greater momentary energy, so a measurement product designed for **CAT III** environments can endure greater momentary energy than one designed for **CAT II**. Using a measurement product in an environment designated with a higher-numbered category than that for which the product is rated could result in a severe accident, and must be carefully avoided.

Never use a **CAT I** measuring product in **CAT II, III, or IV** environments.

The measurement categories comply with the Overvoltage Categories of the IEC60664 Standards.

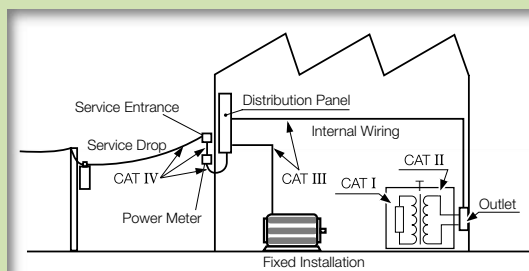

Notes on accuracy ...

The specifications in this catalog include figures for "measurement accuracy" when referring to digital measuring instruments, and for "measurement tolerance" when referring to analog instruments. The accuracy and tolerance figures in the product specifications are defined in terms of *full scale (f.s.) value* and *displayed reading (rdg.)* or *digit resolution (dgt.)* as described below.

f.s. (maximum display, or length of scale, ... full-scale)

Signifies the maximum display (scale) value or the length of the scale (in cases where the scale consists of unequal increments or where the maximum value cannot be defined). In general, this is the range value (the value written on the range selector, or equivalent) currently in use. However, be aware that in cases where the maximum display value is 2000V but the range value is only 600V, the maximum display value (scale value) is still used as the f.s. value.

rdg. (displayed or indicated value, ... reading value)

This signifies the value actually being measured, i.e., the value that is currently indicated or displayed by the measuring instrument.

dgt. (digital resolution, ... digit)

Signifies the smallest display unit on a digital measuring instrument, i.e., the value displayed when the last digit on the digital display is "1". Essentially, this indicates an error of 1 digit (based on decimal processing in analog-to-digital conversion), but in actuality this is the digit error combined with the f.s. error converted to a fraction of a digit unit. The accuracy associated with a particular measured value as shown in the product specifications is derived from these values.



What is the CE Mark?

The CE mark certifies that a product complies with electrical safety standards established by European Community directives (EC directives). These EC directives require conformance of a product to EN/IEC standards for electrical safety.

- HIOKI's products bearing the CE Mark are designed to conform to the Low Voltage and EMC directives based on the EC directives.
- The Low Voltage directive is applicable to products operating from 50 to 1000V AC and 75 to 1500V DC, and require protection from electrical hazards such as electric shock.
- The EMC directive requires suppression of emissions of harmful electromagnetic radiation, and the ability to withstand exposure to external electromagnetic radiation without malfunction.



WARNING



In some cases, power lines may carry voltage spikes of several times the normal supply voltage. For reasons of safety, ordinary testers should not be used to measure power lines carrying more than 250V. When measuring such power lines, always use a tester with built-in overcurrent protection to guard against short circuits, such as Model 3008 and CAT III marked products.

Note : An industrial power line refers to a high-capacity supply circuit to equipment in factories or offices. A high-capacity supply circuit refers generally to a line carrying 20 A or more. This does not therefore include supply lines protected by overcurrent protection (fuses) or distribution breakers.



WARNING



1. To avoid short circuits and electric shock accidents when using a clamp-on sensor, use only with power lines carrying voltages within the rating limit of the sensor.
2. To avoid short circuits and electric shock accidents when the clamp-on sensor is open, do not use on bare conductors.

Contents

About the CatalogP.1
 Model Index.....P.3



Recorders, Memory Recorders P.4 to 20

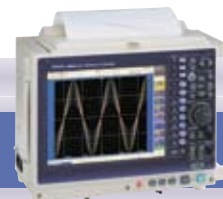

Power Measuring Instruments P.21 to 26



Electronic Measuring Instruments P.27 to 37



Environmental Measuring Instruments P.38 to 41



Clamp Sensors P.42 to 45



Clamp Testers P.46 to 51



Field Measuring Instruments P.52 to 60



Options & Peripherals P.61 to 68

Meter Relays P.61 to P.62
 Test Leads, Test Probes P.63 to P.64
 Electrodes P.65
 Recording Paper, Temperature Sensors P.66
 All Accessories P.67 to P.68



Service, Traceability, CalibrationP.69
 Company Guide & Internet WebsiteP.70

Model Index

1000 or later ...Peripherals

1196. p.67

2000 or later ...Meter relays

2103. p.61

2104. p.61

2300. p.39

7000 or later ...Signal sources

7011. p.37

7016. p.37

7075. p.37

7075-01. p.37

3000 or later ...Multi meters, Current /Insulation /Earth /Rotation /Thermo /Illumination /Power meters

3008. p.52	3196. p.23	3284. p.49	3442. p.41	3511-50. p.30	3661-20. p.60
3030-10. p.59	3197. p.24	3285. p.49	3443. p.41	3522-50. p.31	3662-20. p.60
3490. p.52	3237. p.32	3285-20. p.49	3444. p.41	3532-50. p.31	3663-20. p.60
3120. p.55	3238. p.32	3286-20. p.51	3445. p.41	3535. p.30	3664. p.52
3126-01. p.58	3239. p.32	3287. p.48	3446-01. p.38	3540. p.28	3665-20. p.60
3127-10. p.50	3244. p.54	3288. p.48	3447-01. p.38	3540-01,-02,-03. p.28	3801-50. p.54
3128-10. p.50	3245. p.52	3290. p.50	3451-11 to -15. p.57	3541. p.28	3802-50. p.52
3129-10. p.58	3246. p.54	3290-10. p.50	3452-11 to -13. p.57	3554. p.59	3803. p.54
3144-20. p.20	3255-50. p.55	3291. p.50	3453. p.56	3555. p.59	3804-50. p.52
3145-20. p.20	3256-50,-51. p.55	3293. p.50	3454-10. p.57	3560. p.29	3805-50. p.52
3151. p.58	3257-50,-51. p.55	3331. p.21	3454-11,-51. p.57	3561,-01. p.29	3851-10. p.63
3153. p.34	3269. p.43	3332. p.26	3455. p.56	3632-20. p.40	3856-01. p.67
3154. p.35	3272. p.43	3333,-01. p.26	3460-50. p.41	3633-20. p.40	3856-02. p.67
3156. p.36	3273-50. p.43	3334,-01. p.26	3470. p.60	3634-20. p.40	3909. p.67
3157-01. p.36	3274. p.43	3403. p.58	3471. p.60	3635-24,-25,-26. p.40	3911-20. p.40
3158. p.34	3275. p.43	3404. p.58	3472. p.60	3636-20. p.40	3912-20. p.40
3159. p.34	3276. p.43	3412-50. p.38	3480-21. p.55	3637-20. p.40	SM-8200. p.33
3169-20,-21. p.22	3280-10. p.48	3415-01. p.38	3481-21. p.55	3638-20. p.40	DSM-8104. p.33
3173. p.36	3280-20. p.48	3416-01. p.38	3481-22. p.55	3639-20. p.40	DSM-8542. p.33
3174/3174-01. p.35	3281. p.49	3418. p.38	3501. p.27	3640-20. p.40	
3193. p.25	3282. p.49	3423. p.41	3504/3504-10. p.30	3641-20. p.40	
3194. p.21	3283. p.49	3441. p.41	3505/3506. p.30	3645-20. p.40	

8000 or later ...Recorders and Peripherals

8205-10. p.19	8731-10. p.16	8842. p.10	8938. p.11	8953-10. p.13	8992. p.14,18
8206-10. p.19	8807-01. p.14	8847. p.7	8939. p.11	8954. p.13	8993. p.18
8420-51. p.18	8808-01. p.14	8855. p.13	8940. p.11	8955. p.13	8994. p.13
8421-51. p.18	8807-51. p.14	8860-50. p.5	8946. p.11	8956. p.6	8995,-01. p.5
8422-51. p.18	8808-51. p.14	8861-50. p.5	8947. p.11	8957. p.6	
8423. p.17	8826. p.10	8870-20. p.15	8950. p.13	8958. p.6	
8715-01. p.4	8835-01. p.10	8936. p.11	8951. p.13	8959. p.6	
8730-10. p.16	8841. p.10	8937. p.11	8952. p.13	8960. p.6	

9000 or later ...Peripherals

9010-50. p.44	9217. p.63	9324. p.12	9446. p.68	9633. p.68	9728. p.68
9014. p.63	9221. p.66	9325. p.12	9447. p.68	9634. p.68	9729. p.68
9017. p.63	9222. p.67	9326. p.64	9451. p.68	9635-9636. p.51	9770. p.64
9018-50. p.44	9223. p.66	9327. p.13	9452. p.64	9637-9638. p.68	9771. p.64
9021-01. p.63	9229. p.66	9328. p.13	9453. p.64	9639. p.64	9772. p.59
9032. p.67	9229-01. p.66	9334. p.19	9454. p.64	9641. p.18	ALLIGATOR CLIPS. p.64
9033. p.67	9231. p.66	9335. p.9	9455. p.64	9642. p.18	CT-101A. p.46
9050. p.67	9232. p.66	9338-9340. p.67	9458. p.23	9643. p.18	CT-2MR. p.62
9060. p.63	9233. p.66	9344-9349. p.67	9459. p.23	9645. p.13	CT-5MRN. p.62
9067. p.63	9234. p.66	9351. p.67	9460. p.64	9645-01. p.13	HB-1. p.62
9081. p.67	9235. p.66	9355. p.67	9461. p.64	9648. p.18	HS-1. p.62
9084. p.67	9236-01. p.66	9360. p.67	9462. p.68	9649. p.18	HS-2. p.62
9094. p.63	9237. p.66	9363. p.67	9465,-10. p.28,59	9650. p.45	220H. p.12
9132-10. p.42	9257. p.63	9371. p.67	9466. p.64	9651. p.45	SME8301. p.65
9140. p.63	9261. p.63	9372. p.67	9467. p.64	9652-01. p.18	SME8302. p.65
9143. p.63	9262. p.63	9375. p.67	9472-9479. p.66	9657. p.45	SME8310. p.65
9148. p.67	9263. p.63	9376. p.67	9517. p.68	9657-10. p.45	SME8311. p.65
9151-02. p.67	9267. p.34,35	9377. p.67	9518-01. p.31	9658. p.45	SME8330. p.65
9151-04. p.67	9268. p.63	9378. p.67	9540-01. p.68	9660-9661. p.45	SME8335. p.65
9165/66. p.63	9269. p.63	9380. p.67	9549. p.13	9667. p.45	SME8350. p.65
9168. p.63	9272-10. p.44	9382. p.67	9555-10. p.44	9668. p.45	SME8360. p.65
9170. p.63	9277. p.44	9384. p.67	9557. p.68	9669. p.45	SR-2. p.65
9177. p.63	9278. p.44	9386. p.67	9558. p.68	9663. p.13	
9179. p.63	9279. p.44	9388. p.67	9588. p.68	9670. p.23	
9180 to 83. p.66	9287-10. p.64	9390. p.67	9593-01. p.31	9671. p.23	
9184. p.66	9288. p.64	9391. p.67	9598. p.68	9672. p.23	
9185. p.63	9290-10. p.42	9392. p.67	9599. p.68	9675. p.45	
9190. p.63	9292. p.64	9393. p.67	9600. p.25	9677. p.30	
9195. p.63	9293. p.64	9397-01. p.67	9601. p.25	9678. p.30	
9196. p.63	9294. p.64	9398. p.67	9602. p.25	9680. p.68	
9197. p.12	9296. p.64	9399. p.67	9603. p.25	9686. p.68	
9198. p.12	9297. p.64	9418-10,-15. p.67	9604. p.25	9694. p.45	
9199. p.12	9299. p.64	9425. p.68	9605. p.25	9695. p.45	
9203. p.67	9303. p.12	9433. p.68	9612. p.14, 18	9699. p.30	
9207-10. p.63	9305. p.67	9436. p.68	9613. p.68	9700-10. p.30	
9208. p.63	9318. p.67	9438. p.64	9614. p.68	9704. p.44	
9209. p.48	9319. p.67	9439. p.68	9615. p.64	9709. p.44	
9211. p.67	9320. p.12	9440. p.68	9617. p.64	9713. p.68	
9212. p.67	9320-01. p.12	9441. p.68	9618. p.64	9714. p.68	
9213. p.67	9321. p.12	9442. p.68	9624-50. p.25	9720. p.68	
9214. p.58	9321-01. p.12	9443-02,-03. p.68	9625. p.22	9725. p.9	
9215. p.58	9322. p.12	9444. p.68	9631. p.68	9726. p.68	
9216. p.67	9323. p.67	9445-02,-03. p.68	9632. p.68	9727. p.68	

Recorders, Memory Recorders









Recorders, Memory Recorders Index

Handy units for service and maintenance recording

 <p>8870-20 €€ 1 MS/sec (2 ch) 2 MW/ch memory 12 bit A/D resolution handy Typep.15</p>	 <p>8807-01/8808-01 €€ 400 kS/sec.(4 ch) 256 kW (1 ch) memory 12 bits A/D resolution Battery operationp.14</p>	 <p>8835-01 €€ 1 MS/sec.(8 ch) 4 MW (1 ch) memory 12 bits A/D resolutionp.10</p>	 <p>8205-10 €€ Recorder (1 ch) 100 sampling/sec. No memoryp.19</p>	 <p>8420-51/8421-51 €€ 8422-51 Data logger (8 ch,16 ch) 100 ms to 1h interval 16 MW internal memory 16 bits A/D resolution Battery operationp.18</p>	 <p>8847 €€ 20MS/sec Analog 16ch + Logic 16ch to Analog 10ch + Logic 64ch 12/16 bit A/D resolutionp.7</p>
--	--	--	--	---	---

For simultaneous recording of multiple signals

 <p>8860-50 €€ 20 MS/sec. (12 bits 8 ch) 2 MS/sec. (16 bits 8 ch) 50 ms/all ch (16 bits 64 ch) 32 MW up to 1GW memoryp.5</p>	 <p>8861-50 €€ 20 MS/sec. (12 bits 16 ch) 2 MS/sec. (16 bits 16 ch) 50 ms/all ch (16 bits 128 ch) 64 MW up to 2GW memoryp.5</p>	 <p>8841 €€ 1 MS/sec. (8/16 ch) 4 MW (1 ch) memory (expandable up to four) 12 bits A/D resolutionp.10</p>	 <p>8842 €€ 1 MS/sec. (16 ch) 4 MW (1 ch) memory (expandable up to four) 12 bits A/D resolutionp.10</p>	 <p>8826 €€ 1 MS/sec. (32 ch) 4 MW (1 ch) memory (expandable up to four) 12 bits A/D resolutionp.10</p>	 <p>8423 €€ 15 ch to 600 ch isolated input Minimum 10 ms interval LAN/USB PC base data acquisitionp.17</p>
---	--	--	--	--	---

For waveform capture of high-speed signals



8855 €€
8 channels
20 MS/sec.(8 ch)
Max. 512 MW memory
12 bits A/D resolution
(16 bits A/D 1 MS/sec.)
.....p.13

Options for MEMORY HiCORDER series WAVE COMPARATOR



.....p.5,6,8,9,11,12



8730-10/8731-10 €€
Geared for the
Production line
8730-10: 1ch input
8731-10: 2ch input
.....p.16

For power line fault monitoring

 <p>8206-10 €€ Recorder for power lines 100 sampling/sec.(2 ch) AC voltage and current No memoryp.19</p>	 <p>8715-01 €€ Recorder for power lines 400 kS/sec.(4 ch) 64 kW/ch memory 12 bits A/D resolution Battery operation</p>	 <p>8807-51 €€ Harmonic analysis 400 kS/sec (2 ch) 256 kW (1 ch)Memory 12 bits A/D resolutionp.14</p>	 <p>8808-51 €€ Harmonic analysis 400 kS/sec (4 ch) 256 kW (1 ch)Memory 12 bits A/D resolutionp.14</p>
--	--	---	---

NOISE HiLOGGER



3145-20 €€
Measures the noise
levels and frequencies
on telecom, power and
grounding lines
.....p.20

NOISE SEARCH TESTER



3144-20 €€
Identify noise in
communication and
power lines
Frequency range 50 Hz
to 30 MHz
.....p.20

MEMORY HiCORDER | 8860-50 | 8861-50

HIOKI's Next Generation Recorder
High Performance Isolated High-speed Recorder and
Data Logger All in One Complete Instrument



- High and Low Speed Dual Sampling - High speed at 20MS/s (with 8956 input unit)
- Maximum 128 channels (8861) or 64 channels (8860) of data logging
- Large capacity memory, LAN/USB and other popular PC interfaces standard
- Intuitive operation using GUI/mouse/keyboard

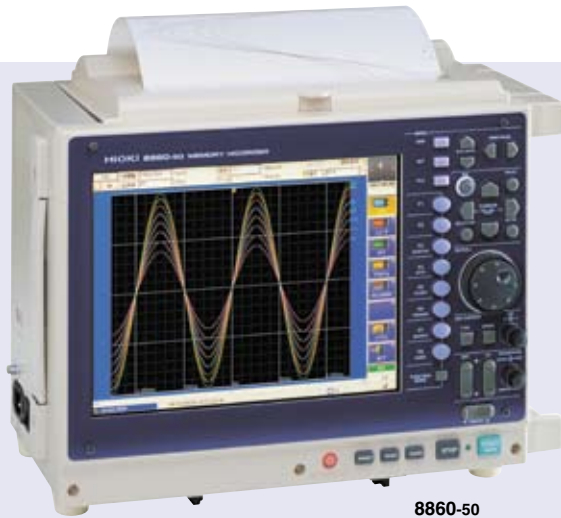

8860-50

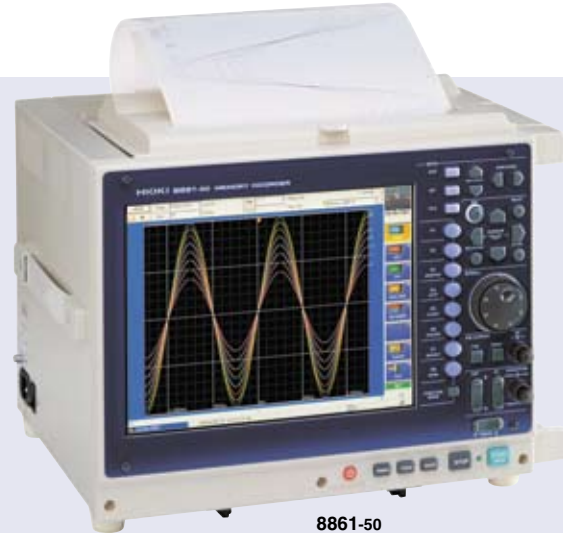

8861-50

Recorders, Memory Recorders

SPECIFICATIONS

Measurement ranges <small>using 8956 ANALOG UNIT /option</small>	5 mV to 20 V/division, 12 ranges (20 divisions f.s.), resolution: 1/100 of range
Frequency band	DC to 10 MHz ± 3 dB (using 8956 ANALOG UNIT /option)
Time axis at memory function	5 μ s to 5 minutes/division, 26 settings; external sampling (100 samples/division, desired setting)
Measurement functions	Memory, Recorder, Recorder & Memory (Version 2.00 or later), FFT, Real-time save function
Number of input channels	8860-50: Analog (up to 16 channels) + logic (32 channels standard) or Logger Input (up to 64 channels) 8861-50: Analog (up to 16 channels) + logic (16 channels standard) or Logger Input (up to 128 channels)
Memory capacity	8860-50: 32 M words/9715 \times 1 (Total 1 GW, 9715-03 (x1)) 8861-50: 64 M words/9715 \times 2 (Total 2 GW, 9715-03 (x2))
Data storage	Type II PC card slot, Hard disk drive (optional)
Interfaces	USB2.0 (3 ports), LAN, GP-IB (with GP-IB CARD 9558), Monitor output (SVGA)
Recording and display	10.4-inch TFT color LCD, 216 mm \times 30 m (A4) or 112 mm \times 18m (A6), thermal paper roll
Other functions	Scaling, Vernier function, cursor measurement, comment insertion, other functions
Power supply	100 to 240 V AC (50/60 Hz)
Dimensions, mass (base unit only)	8860-50: 330 mmW \times 250 mmH \times 184.5 mmD, 8.0 kg 8861-50: 330 mmW \times 250 mmH \times 284.5 mmD, 10.5 kg
Accessories	Power cord (1), input cord label (1), Wave viewer software (1)

OPTIONS

(The 8860 or 8861 cannot be used alone. Measurement requires optional input unit or similar peripheral.)

●Options (Factory fitted)			
A4 PRINTER UNIT	8995	MEMORY BACK UP UNIT	9719-50
A6 PRINTER UNIT	8995-01	DC POWER UNIT	9684
MEMORY BOARD(32MW to 1GW)*	9715-50,-51,-52,-53	PROBE POWER UNIT	9687
HD UNIT	9718-50		
●Options			
CONNECTION CORD (500V Max.)	9197	LOGIC PROBE (for 20Ms)	9327
CONNECTION CORD (300V Max.)	9198	LOGIC PROBE	9320-01
CONNECTION CORD (BNC-BNC)	9217	LOGIC PROBE	9321-01
10:1 PROBE	9665	CARRYING CASE (for 8860)	9723
100:1 PROBE	9666	CARRYING CASE (for 8861)	9724
RECORDING PAPER (for A4-printer 8995 only)	9231	MEMORY HiVIEWER	9725
A4 width 216 mm \times 30 m, 6 rolls		LAN CABLE	9642
RECORDING PAPER (for A6-printer 8995-01 only)	9234	PC CARD 128MB	9726
A6 width 112 mm \times 18 m, 10 rolls		PC CARD 256MB	9727
DIFFERENTIAL PROBE (9418-15 or 9687/9248 is necessary)	9322	PC CARD 512MB	9728
		PC CARD 1GB	9729
		CLAMP ON SENSORS (refer to p.42-45)	
		Other common options (refer to p.12)	

*One MEMORY BOARD is required in Model 8860, and two MEMORY BOARDS of the same capacity are required in Model 8861

<p>(refer to P.6,11)</p>	Input modules	
	ANALOG UNIT (20MS/s)	8956
	HIGH RESOLUTION UNIT	8957
	16ch SCANNER UNIT	8958
	DC/RMS UNIT	8959
	ANALOG UNIT (1MS/s)	8936
	VOLTAGE/TEMP UNIT	8937
	FFT ANALOG UNIT	8938
	STRAIN UNIT (12Bit)	8939
	F/V UNIT	8940
	4ch ANALOG UNIT	8946
	CHARGE UNIT	8947
	STRAIN UNIT (16Bit)	8960
HIGH VOLTAGE UNIT	8961	

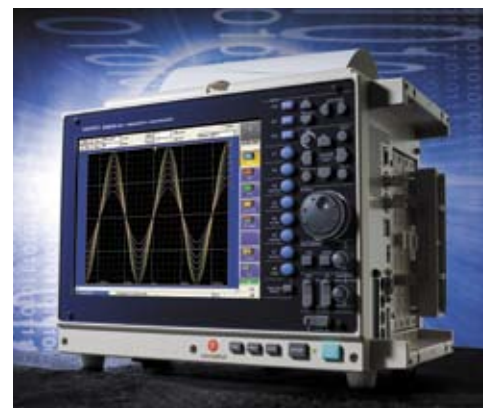

INPUT Units For 8860-50, 8861-50 only

Dimensions and mass: approx.
170W × 20H × 148.5D mm, approx. 290g
Accessories: None



8956

ANALOG UNIT 8956	
Measurement functions	Number of channels: 2, for voltage measurement
Input connectors	Isolated BNC connector (input impedance 1 MΩ, input capacitance 40 pF), Max. rated voltage to earth: 300 V AC, DC (with input isolated from the unit, the maximum voltage that can be applied between input channel and chassis and between input channels without damage)
Measurement range	5 mV to 20 V/division, 12 ranges, full scale: 20 divisions, AC voltage for possible measurement/display using the memory function: 280 V rms, low-pass filter: 5/500/5k/1M Hz
Measurement resolution	1/100 of measurement range (using 12-bit A/D conversion; installed in 8860/8861)
Highest sampling rate	20 MS/s (simultaneous sampling in 2 channels)
Accuracy	DC amplitude: ±0.4% of full scale (with filter 5 Hz) Zero position: ±0.1% of full scale (with filter 5 Hz, after zero adjustment)
Frequency characteristics	DC to 10 MHz ±3 dB, with AC coupling: 7 Hz to 10 MHz ±3 dB
Input coupling	DC, GND, AC
Max. allowable input	400 V DC (the maximum voltage that can be applied across input pins without damage)

Dimensions and mass: approx.
170W × 20H × 148.5D mm, approx. 310 g
Accessories: None



8957

HIGH-RESOLUTION UNIT 8957	
Measurement functions	Number of channels: 2, for voltage measurement
Input connectors	Isolated BNC connector (input impedance 1 MΩ, input capacitance 40 pF), Max. rated voltage to earth: 300 V AC, DC (with input isolated from the unit, the maximum voltage that can be applied between input channel and chassis and between input channels without damage)
Measurement range	5 mV to 20 V/division, 12 ranges, full scale: 20 divisions, AC voltage for possible measurement/display using the memory function: 280 V rms, low-pass filter: 5/50/500/5k/50k Hz
Anti-aliasing filter	Integrated filter for suppressing aliasing distortion caused by FFT processing (automatic cutoff frequency setting/OFF)
Measurement resolution	1/1600 of measurement range (using 16-bit A/D conversion; installed in 8860/8861)
Highest sampling rate	2 MS/s (simultaneous sampling in 2 channels)
Accuracy	DC amplitude: ±0.2% of full scale (with filter 5 Hz) Zero position: ±0.1% of full scale (with filter 5 Hz, after zero adjustment)
Frequency characteristics	DC to 200 kHz ±3 dB, with AC coupling: 7 Hz to 200 kHz ±3 dB
Input coupling	DC, GND, AC
Max. allowable input	400 V DC (the maximum voltage that can be applied across input pins without damage)

Dimensions and mass: approx.
170W × 20H × 183D mm, approx. 385 g
Accessories: Flathead screwdriver × 1, short bar × 2



8958

16ch SCANNER UNIT 8958	
Measurement functions	Number of channels: 16, for voltage measurement/temperature measurement with thermocouple
Input connectors	Voltage input/Thermocouple input: screw-type terminal strip, recommended wire diameter *, detachable terminal block (with cover) *1 Recommended cable, single-wire: 0.14 to 1.5 mm ² , braided wire 0.14 to 1.0 mm ² (conductor wire diameter min. 0.18 mm), AWG 26 to 16 Input impedance: 1 MΩ, 850 kΩ with line fault detection ON, Max. rated voltage to earth: 33 Vrms or 70 V DC (with input isolated from the unit, the maximum voltage that can be applied between input channel and chassis and between input channels without damage)
Voltage measurement range	5m, 50m, 500m, 2 V/division, 4 ranges, full scale: 20 divisions, measurement range: ±100% of full scale, digital filter: 10/50/60 Hz, measurement resolution 1/1600 of measurement range (using 16-bit A/D conversion; installed in 8860/8861)
Temperature measurement range <small>(Upper and lower limit values depend on measurement input range of sensor)</small>	10°C/division (-100°C to +200°C), 50°C/division (-200°C to +1000°C), 100°C/division (-200°C to +2000°C), 3 ranges, full scale: 20 divisions, digital filter: 10/50/60 Hz, measurement resolution 1/1000 of measurement range (using 16-bit A/D conversion; installed in 8860/8861)
Thermocouple range <small>(JIS C 1602-1995) (ASTM E-988-96)</small>	K: -200 to 1350°C, J: -200 to 1200°C, E: -200 to 1000°C, T: -200 to 400°C, N: -200 to 1300°C, R: 0 to 1700°C, S: 0 to 1700°C, B: 400 to 1800°C, W (WRe5-26): 0 to 2000°C, reference junction compensation: internal/ external (switchable), line fault detection ON/OFF switchable
Data refresh rate	50 ms/all channels (digital filter OFF), 300 ms/all channels (digital filter 50/60 Hz), 1.4 s/all channels (digital filter 10 Hz)
Accuracy	Voltage: ±0.2% of full scale, thermocouple (K, J, E, T, N): ±0.05% of full scale ±1°C, (R, S, B, W): ±0.05% of full scale ±2°C (400°C or more), ±0.05% of full scale ±3.5°C (less than 400°C), reference junction compensation accuracy: ±1°C (added to measurement accuracy with internal reference junction compensation)
Max. allowable input	40 V DC (the maximum voltage that can be applied across input pins without damage)

Dimensions and mass: approx.
170W × 20H × 148.5D mm, approx. 290 g
Accessories: None



8959

DC/RMS UNIT 8959	
Measurement functions	Number of channels: 2, for voltage measurement
Input connectors	Isolated BNC connector (input impedance 1 MΩ, input capacitance 30 pF), Max. rated voltage to earth: 370 V AC, DC (with input isolated from the unit, the maximum voltage that can be applied between input channel and chassis and between input channels without damage)
Measurement range	5 mV to 20 V/division, 12 ranges, full scale: 20 divisions, AC voltage for possible measurement/display using the memory function: 280V rms, low-pass filter: 5/500/5k/100k Hz
Measurement resolution	1/80 of measurement range (using 12-bit A/D conversion; installed in 8860/8861)
Highest sampling rate	1 MS/s (simultaneous sampling in 2 channels)
Accuracy	DC amplitude: ±0.4% of full scale (with filter 5 Hz), zero position: ±0.1% of full scale (with filter 5 Hz, after zero adjustment)
RMS measurement	RMS amplitude accuracy: ±1% of full scale (DC, 20 Hz to 1 kHz), ±3% of full scale (1 kHz to 100 kHz), response time: SLOW 5 s (rise time from 0 to 90% of full scale), MID 800 ms (rise time from 0 to 90% of full scale), FAST 100 ms (rise time from 0 to 90% of full scale), crest factor: 2
Frequency characteristics	DC to 400 kHz ±3 dB, with AC coupling: 7 Hz to 400 kHz ±3 dB
Input coupling	DC, GND, AC
Max. allowable input	400 V DC (the maximum voltage that can be applied across input pins without damage)

Dimensions and mass: approx.
170W × 20H × 148.5D mm, approx. 290 g
Accessories: Conversion cable × 2, cable length 50cm



8960

STRAIN UNIT 8960	
Measurement functions	Number of channels: 2, for distortion measurement (electronic auto-balancing, balance adjustment range within ±10000 με)
Input connectors	Via conversion cable, TAJIMI PRC03-12A10-7M10.5, Max. rated voltage to earth: 33 Vrms or 70 V DC (with input isolated from the unit, the maximum voltage that can be applied between input channel and chassis and between input channels without damage)
Suitable transducer	Strain gauge converter, bridge impedance: 120 Ω to 1 kΩ (bridge voltage 2 V), 350 Ω to 1 kΩ (bridge voltage 5 V, 10 V), bridge voltage 2, 5, 10 ±0.05 V
Measurement range	20 με to 1000 με/division, 6 ranges, full scale: 20 divisions, low-pass filter: 5/10/100/1k Hz
Anti-aliasing filter	Integrated filter for suppressing aliasing distortion caused by FFT processing (automatic cutoff frequency setting/OFF)
Measurement resolution	1/1600 of measurement range (using 16-bit A/D conversion; installed in 8860/8861)
Highest sampling rate	200 kS/s (2-channel simultaneous sampling)
Accuracy After auto-balancing	DC amplitude: ±(0.4% of full scale + 2 με), zero position: ±(0.1% of full scale + 2 με) (at 5 Hz filter ON)
Frequency characteristics	DC to 20 kHz +1/-3 dB
Max. allowable input	10 V DC (the maximum voltage that can be applied across input pins without damage)

* Available from main unit 8860/8861 version 1.06

Dimensions and mass: approx.
170W × 19.8H × 148.5D mm, approx. 310 g
Accessories: CONNECTION CORD 9242 × 2 (1.7 m.), GRABBER CLIP 9243 × 2



8961

HIGH VOLTAGE UNIT 8961	
Measurement functions	Number of channels: 2, for voltage measurement, DC/RMS selectable (10Mohm 5pF)
Measurement range	1 V to 50 V/div, 6 ranges, full scale: 20 div, Max. 700 V rms, low-pass filter: 5/50/500/5 kHz
Highest sampling rate	2 MS/s (simultaneous sampling in 2 channels)
Accuracy	DC amplitude: ±0.25% of full scale (with filter 5 Hz)
RMS measurement	RMS amplitude accuracy: ±1% of full scale (DC, 40 Hz to 1 kHz, sine waveform), crest factor: 2
Frequency characteristics	DC to 100 kHz ±3dB, Install only up to four units in one 8860-50 series
Max. allowable input	1000 V DC (the maximum voltage that can be applied across input pins without damage)

MEMORY HiCORDER | 8847

Rapid 20MS/s sampling with isolated inputs

- Analog 16ch + Logic 16ch to Analog 10ch + Logic 64ch
- Fast built-in printer with single-touch operation
- LAN and USB interfaces
- Ruggedly designed to protect against dusty environments



LAN STANDARD

USB 2.0 STANDARD



Japanese Version

Recorders, Memory Recorders

SPECIFICATIONS

Measurement ranges (10div full scale)	5mV/div to 20V/div (12 ranges), Resolution: 1/100 of range Max. input voltage 400V DC
Frequency band	DC to 5MHz (± 3 dB)
Time axis range	5 μ s to 5 min/div, 26 ranges (1 division = 100samples)
Measurement function	Memory, Recorder, X-Y Recorder (option: Recorder and Memory, FFT)
Number of channels	Analog 16ch + Logic 16ch to Analog 10ch + Logic 64ch
Memory capacity	Total 64M-Words 32MW/ch (2ch), 16MW/ch (4ch), 8MW/ch (8ch), 4MW/ch (16ch)
Data storage	CF Card Slot (Max1GB), Hard disk drive (option 80GB)
Display	10.4 inch TFT color LCD (SVGA, 800 x 600 dots)
Recording	216 mm x 30 mm
Interface	USB 2.0, LAN: 100BASE-TX
Power supply	100 to 240 V AC (50/60 Hz)
Dimensions, mass	351W x 261H x 140D mm, 6.7kg
Accessories	Printer paper (1), Power cord (1), Protective cover (1), Roll paper attachment (2), PC card protector (1), Application Disk (Wave Viewer Wv, Communication Commands table) (1), USB cable (1)

OPTIONS

ANALOG UNIT	8966	100:1 PROBE	9666
HIGH RESOLUTION UNIT	8968	LOGIC PROBE	9320-01
DC/RMS UNIT	8972	LOGIC PROBE	9321-01
TEMP UNIT	8967	LOGIC PROBE	9327
FREQ UNIT	8970	DIFFERENTIAL PROBE	9322
CURRENT UNIT 8971		(9418-15 is necessary)	
STRAIN UNIT	8969	POWER CORD (8970-9322)	9325
LOGIC UNIT	8973	PC CARD 128MB	9726
HD UNIT	9664 (Factory fitted)	PC CARD 256MB	9727
DC POWER UNIT	9784 (Factory fitted)	PC CARD 512MB	9728
FUNCTION UP CARD	9785	PC CARD 1GB	9729
CONNECTION CORD	9197	RECORDING PAPER	9231
CONNECTION CORD	9198	LAN COMMUNICATOR	9333
CONNECTION CORD	9217	WAVE PROCESSOR	9335
10:1 PROBE	9665	CARRYING CASE	9783





MEMORY HiVIEWER (for 8860-50,8861-50) | 9725

Perform 8860-50 and 8861-50 functions on your PC

- Application software enables you to perform the same data analysis on a Windows computer as on the 8860-50 and 8861-50 MEMORY HiCORDERs.
- No confusion, because the screens appearing on the computer are identical to those of the 8860-50 / 8861-50.
- Functions identical to those of the 8860-50 / 8861-50, such as waveform processing calculation, run on the computer.

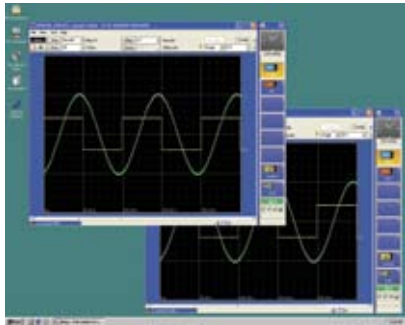

SPECIFICATIONS	
Compatible devices	MEMORY HiCORDER 8860-50, 8861-50
Supplied Media	One CD-R disc
Operating environment	Computer running under Windows 2000/XP / Vista
File loading	Readable data formats : Only for 8860-50, 8861-50 data (.MEM, .REC, .SEQ, .IDX, .SET) Maximum file size : 2 GW
File saving	Saved contents: measurement data (binary and ASCII), (partial saving of the area between cursors A and B), setting conditions, screen image (BMP, PNG), and calculation results
Display	<ul style="list-style-type: none"> ■ Waveform display: 1-, 2-, 3-, 4-, 6-, and 8-split screen, horizontal, vertical, consecutive scroll, and zoom in/out along the time axis, move the zero position, zoom in/out, setting of variables independently for each channel ■ X-Y-axis composite display (for the MEM function only): 1-, 2-, and 4-split display, dot/line interpolation, composite area can be specified ■ Numerical display: digital values of waveform data can be displayed ■ Display sheet: 16 sheets ■ Display channel count (per sheet): 32 analog channels, 16 logic channels, 16 calculated waveforms, 8 X-Y-axis composite waveforms ■ Cursor function: vertical cursor, horizontal cursor, trace cursor, two cursors (cursor A and cursor B), time and voltage display ■ Clipboard copy: images on the waveform screen can be transferred to the clipboard
Print	<ul style="list-style-type: none"> ■ Supported printer: printer compatible with the OS ■ Print format: waveform image (1-, 2-, 3-, 4-, 6-, 8-, and 16-split), numerical print, report format, list print, calculation results, screen image ■ Print area: the entire area, area between cursors A and B ■ Print preview

WAVE PROCESSOR (for MEMORY HiCORDER) | 9335

Display, Convert, Calculate and Print Waveforms on a PC

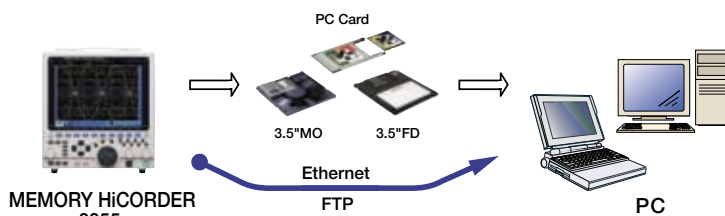

*Note: The use of MO discs, PC cards, and floppy disks and the availability of a LAN connection depend on the specifications of the recorder model in question.

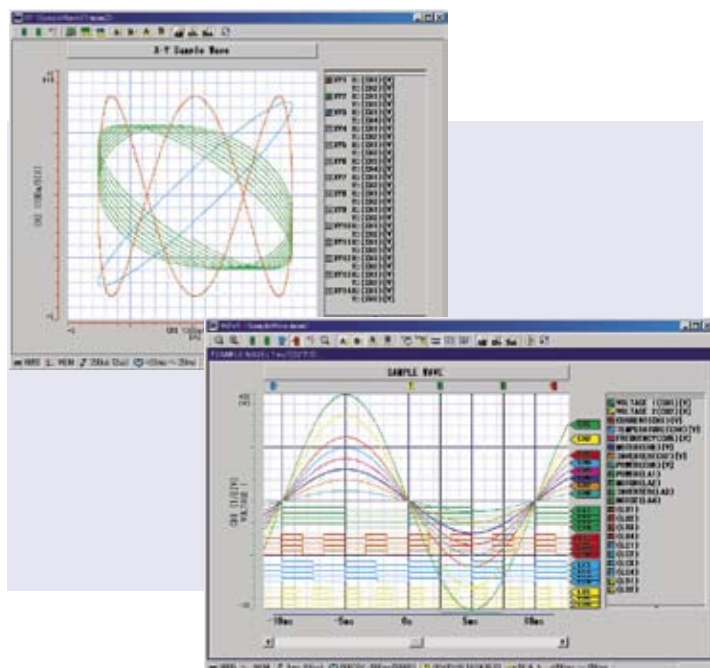

SPECIFICATIONS	
Compatible devices	MEMORY HiCORDER; 8807 (-01/-51), 8808 (-01/-51), 8826, 8835 (-01), 8841, 8842, 8855, 8860-50, 8861-50 (2 time axis impossible) POWER HiCORDERs 8714 (-01), 8715 (-01); VISUAL HiCORDER; 8720 WAVE COMPARATOR; 8730-10, 8731-10
Supplied Media	One CD-R disc
Operating environment	Computers running Windows 95, 98, Me, NT4.0, 2000 or XP, Vista Pentium (133MHz) or better, at least 32MB of memory (Recommended: Pentium (200MHz) or better, at least 64MB of memory)
Display functions	<ul style="list-style-type: none"> ■ Waveform Display: Displays image of loaded waveform data on screen ■ X-Y display: Memory function format (.MEM file) only ■ Digital Value Display: Displays waveform data as digital values, and allows images and digital values to be displayed simultaneously ■ Cursor function: Allows you to display the time and potential differences between cursors A and B, the time and electrical potential between each cursor, and the absolute and relative times ■ Scroll function: available ■ Maximum number of channels: 32 analog channels, 32 logic channels ■ Gauge display: Time gauge, voltage axis gauge ■ Graphical input: Possible
File loading	<ul style="list-style-type: none"> ■ Loading data format: Memory (.MEM, except for data stored in real time); recorder (.REC), effective value recorder (.RMS) ■ Maximum loadable file size: Maximum size that can be stored by hardware. The maximum size that can be handled may be smaller in some PC environments.)
Data conversion functions	<ul style="list-style-type: none"> ■ Target data: All data, data between cursors ■ Data interval: Simple interval (number of samples can be specified) ■ Data conversion: Converts analog waveform data into numeric values, converts logic data into binary ■ Data conversion format: CSV format, tab delimited, space delimited (selectable when data is saved) ■ Conversion channel: Can be selected when data is saved ■ Batch conversion: Multiple files can be specified for batch conversion
Printing functions	<ul style="list-style-type: none"> ■ Printing format: Can print no partitions, 2 to 16 partitions, 2 to 16 columns, X-Y 1 to 4 partitions, gauges, channel comments ■ Print preview: Possible ■ Waveform screen hard copy: Possible ■ Compatible printers: Any printer supported by the OS (color or black and white)
Parameter calculation functions	<ul style="list-style-type: none"> ■ Target data: All data, data between cursors ■ Calculation items: Average value, effective value, peak value, maximum value, time of maximum value, minimum value, time of minimum value, rise time, fall time, standard deviation, area, cycle, frequency, pulse width, duty ratio, ON time, OFF time, number of times turned ON
Other	<ul style="list-style-type: none"> ■ Search functions: Event mark, date and time (absolute time, time relative to trigger), maximum, minimum, absolute maximum, absolute minimum, level up/down, window in/out ■ Clipboard copy: Waveform screen, cursor value, digital value, file information ■ Startup of other applications: Other applications can be launched by specifying run file

MEMORY HiCORDER

8835-01

High-visibility, Compact, Multi-channelled
Field measurement has never been easier

- Compact 4/8 ch recorder saves space with slim profile
- 110mm-width recording paper and a large color display(6.4-inch)
- Maximum 8 analog channels and 16 logic

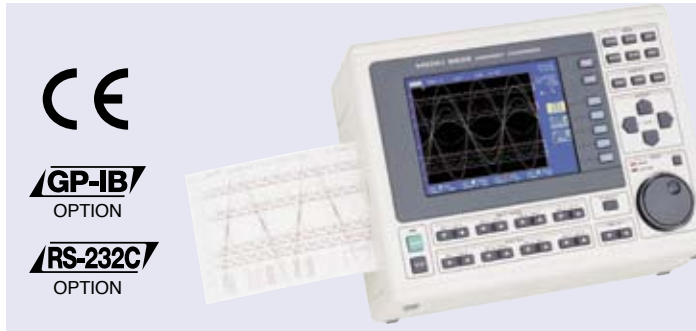

GP-IB
OPTION

RS-232C
OPTION

SPECIFICATIONS

Measurement ranges using 8936 ANALOG UNIT /option	10mV to 50V/division, 12 ranges (10 division f.s.) resolution: 1/160 of range
Frequency band	DC to 400kHz, ±3dB
Time axis at memory function	100µs to 5 minutes/division, 20 ranges (1division =100samples)
Functions *Additional functions, using 9540-01 FUNCTION UP DISK /option	Memory recorder, Recorder (included X-Y), RMS recorder (50/60Hz or DC only), *Recorder and Memory, *FFT
Number of input channels using 8936, 8946 ANALOG UNIT /option	4 analog channels plus 16 logic channels (using 8936) 8 analog channels plus 16 logic channels (using 8946)
Memory capacity	12bits×4M words/channel (using 1 channel)
Data storage	FDD×1, Type-III PC card×1; PC CARD 9726-9729
Interfaces	GP-IB, or RS-232C (option, using PC card)
Recording and display	110mm×30 m, roll type thermal paper, Recording speed: 25mm/s, 6.4-inch color TFT LCD
Other functions	Scaling, Waveform parameter calculations, Memory segmentation, Cursor readout, etc.
Power supply	100 to 120V AC or 200 to 240V AC (50/60 Hz) * 10 to 28V DC, using the DC POWER ADAPTER 9439
Dimensions, mass	285W×220H×132D mm, 4.5kg
Accessories	Power cord(1), Recording paper(1 roll), Dust cover(1), PC card protector(1), Wave viewer software(1)

Input Units: refer to P.11
Options: refer to P.12

MEMORY HiCORDER

8841 8842

Mainstream recorder with 16 fully isolated
channels

- A4-width recording paper and a large color display(10.4-inch)
- Maximum 16 analog channels and 16 logic
- High performance and easy operation

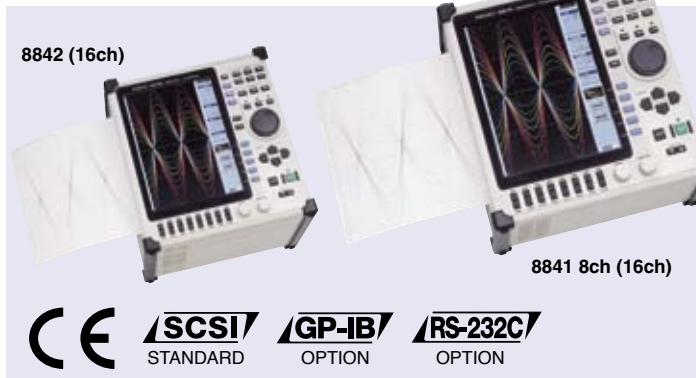

8842 (16ch)

8841 8ch (16ch)



SCSI
STANDARD

GP-IB
OPTION

RS-232C
OPTION

SPECIFICATIONS

Measurement ranges using 8936 ANALOG UNIT /option	5 mV to 20 V/division, 12 ranges (20 division f.s.) resolution: 1/80 of range
Frequency band	DC to 400 kHz, ±3dB
Time axis at memory function	100µs to 5 minutes/division, 20 ranges (1division =100samples)
Functions	Memory recorder, Recorder (included X-Y), RMS recorder (50/60 Hz or DC only), Recorder and Memory, FFT
Number of input channels using 8936, 8946 ANALOG UNIT /option	8-analog plus 16-logic channels :8841 (using 8936) 16-analog plus 16-logic channels :8841 (using 8946) 16-analog plus 16-logic channels :8842 (using 8936)
Memory capacity	12 bits×4 M words*/channel (using 2 channels) *Memory capacity can be expanded 4 times.
Data storage	FDD×1, Type-III PC card×1; SRAM, flash ATA, hard-disk card
Interfaces	GP-IB, SCSI (for MO drive connection, standard), RS-232C, external printer (option, use PC card)
Recording and display	216 mm×30 m, roll type thermal paper, Recording speed: 25 mm/s, 10.4-inch color TFT LCD
Other functions	Scaling, Waveform parameter calculations, Memory segmentation, Cursor readout, etc.
Power supply	100 to 240 V AC (50/60 Hz) * 10 to 28 V DC, using DC POWER ADAPTER 9433
Dimensions, mass	280W×300H×140D mm, 6.0kg :8841 280W×300H×220D mm, 7.0kg :8842
Accessories	Power cord(1), Recording paper(1 roll), Dust cover(1), PC card protector(1), Wave viewer software(1)

Input Units: refer to P.11
Options: refer to P.12

MEMORY HiCORDER

8826

32-channel recorder with all isolated inputs

- Simultaneous sampling, display and recording of all 32 analog and 32 logic channels
- Large capacity memory of max. 16M-word
Memory expandable four times (option)
- High resolution of 12-bit, 1 M-sampling /second
- B4-size (paper width 264 mm) wide printer
- High-visibility waveforms displayed on a 10.4-inch color TFT liquid crystal display



SCSI
STANDARD

GP-IB
OPTION

RS-232C
OPTION

SPECIFICATIONS

Measurement ranges	5 mV to 20 V/division, 12 ranges (normal f.s.; 20 division, wide f.s.; 24 division), resolution: 1/80 of range
Frequency band	DC to 400 kHz, ±3dB
Time axis at memory function	100µs to 5 minutes/division, 20 ranges (1 division =100 samples)
Functions	Memory recorder, Recorder (included X-Y), RMS recorder, Recorder and Memory, FFT
Number of input channels	32 analog channels plus 32 logic channels
Memory capacity	(analog 12 bits)×4M words/channel (using 4ch) * Expandable up to four, using 9599 MEMORY BOARD
Data storage	FDD×1, Type-III PC card×1; SRAM, flash ATA, PC CARD 9726-9729
Recording and display	264 mm×30 m, roll type thermal paper, Recording speed: 25 mm/s, 10.4-inch color TFT LCD
Other functions	Scaling, Waveform judgment, Waveform processing calculations, Waveform parameter calculations, Memory segmentation, Logging print, Clock, Cursor readout, Comment entry, etc.
Power supply	100 to 240 V AC, 50/60 Hz
Dimensions, mass	401W×235H×382D mm, 11 kg (excluding input units)
Accessories	Power cord(1), Recording paper(1 roll), Dust cover(1), PC card protector(1), Wave viewer software(1)

Input Units: refer to P.11
Options: refer to P.12

INPUT Units

For 8826, 8835-01, 8841, 8842, 8860-50, 8861-50

Dimensions and mass:

Approx. 170W × 20H × 148D mm, approx. 290g

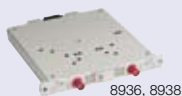

8936, 8938

ANALOG UNIT 8936

Input	Number of channels: 2, Connector: Insulated BNC * Input isolated from output, inter-channel isolation
Measurement range	5mV to 20V/ division, 12 ranges, full-scale (f.s.) = 20 divisions, AC voltage for possible measurement/ display using the memory function : 280V rms, Low-pass filter, 5/500/ 5k/ 100kHz, the measurement resolution is 1/80 of range * When used with 8841, 8842
Maximum sampling rate	1 MS/s (simultaneous sampling of two channels)
Accuracy	DC amplitude: ±0.4%f.s. Zero-position: ±0.1%f.s.
Zero-position	-50% to 150%, 1 % step * With zero-adjustment function
Frequency characteristics	DC to 400kHz ±3 dB, with AC coupling: 7Hz to 400kHz ±3dB
Input resistance and capacitance	1MΩ, 30 pF approx. (at C 100kHz)
Input coupling	DC, GND, AC
Max. allowable input	400V DC (upper voltage which when applied to between input pins does not damage them)
Max. rated voltage to earth	370V AC, DC (upper voltage which when applied to input channel casing or between input channels does not damage them)
Accessories	None * Input cord optional

FFT ANALOG UNIT 8938

Anti-aliasing filter	Cutoff frequency 20, 40, 80, 200, 400, 800, 2k, 4k, 8k, 20k, 40kHz auto-select (linked to frequency range)
Other functions	Same as the ANALOG UNIT 8936
Accessories	None *Input cord optional

Dimensions and mass:

Approx. 170W × 20H × 148D mm, approx. 300g



8937

VOLTAGE/TEMPERATURE UNIT 8937

Inputs	Number of channels: 2 each for voltage and temperature * Input isolated from output, inter-channel isolation Voltage input: isolated BNC, thermocouple input: plug-in terminal
Voltage measurement range	500μV to 2V/ division; 12 settings, full-scale (f.s.) = 20 divisions, low-pass filter: 5/500/5k/ 100kHz, the measurement resolution is 1/80 of range * When used with 8841, 8842
Temperature measurement range	10°C to 100°C/ division; 4 settings, full-scale (f.s.) = 20 divisions, low-pass filter: 5/ 500Hz, measurement resolution: 1/80 of range * When used with 8841, 8842
Thermocouple range	K: -200 to 1350°C, E: -200 to 800°C, J: -200 to 110°C, T: -200 to 400°C, N: -200 to 1300°C, R: 0 to 1700°C, S: 0 to 1700°C, B: 300 to 1800°C, Reference junction compensation: internal/ external (switchable)
Max. sampling rate	Voltage input: 1 MS/s, Temperature measurement: 4Ks/s (2-channel simultaneous sampling)
Accuracy	Voltage input: DC amplitude ±0.4% of f.s. Zero-position ±0.15% of f.s. Temperature measurement (K, E, J, T, N): ±0.1% of f.s. ±1°C, ±0.1% of f.s. ±2°C (-200 to 0°C), (R, S): ±0.1% of f.s. ±3°C, (B): ±0.1% of f.s. ±4°C (400 to 1800°C) Reference junction compensation accuracy: ±0.1 % f.s. ±1.5°C (internal compensation)
Zero position	Voltage input: -50% to 150%, 1% steps * With zero-adjust function Temperature measurement: -100% to 100%, 1% steps
Frequency characteristics	Voltage input: DC to 400kHz + 1/-3dB Temperature measurement: DC to 1 kHz + 1/-3dB
Input resistance and capacitance	Voltage input: 1 MΩ, 50pF approx. (at C 100 kHz) Temperature measurement: 5.1MΩ
Input coupling	DC, GND, AC
Max. allowable input	30V rms or 60V DC (upper voltage which when applied to between input pins does not damage them)
Max. rated voltage to earth	30V rms or 60V DC (upper voltage which when applied to input channel casing or between input channels does not damage them)
Accessories	None * Input cord optional

Dimensions and mass:

Approx. 170W × 20H × 148D mm, approx. 250g

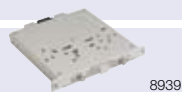

8939

STRAIN UNIT 8939

Inputs	Number of channels: 2, Connector: Adapter cable connector * Input isolated from output, inter-channel isolation
Converter connector	Via adapter cable, TAJIMI PRC03-32A10-7M10.5
Suitable converter	Strain gage converter, bridge impedance: 120Ω to 1kΩ, gage factor 2.00, bridge voltage 2 ±0.05 V
Measurement range	20μe to 1000μe/ division; 6 settings, full-scale (f.s.) = 20 divisions, low-pass filter: 10 Hz, 30 Hz, 300 Hz, 3 kHz, OFF the measurement resolution is 1/80 of range *Using 8841, 8842, 8720
Maximum sampling rate	1 MS/s (simultaneous sampling for 2 channels)
Accuracy (after auto-balancing)	DC amplitude: ±(0.5 % f.s. + 2μe) Zero-position: ±0.5 % f.s.
Balancing	Electronic auto-balancing, max. adjustment range ±10000μe
Zero position	-50 % to 150 %; in 1% steps * With auto-balancing
Frequency characteristics	DC to 20 kHz +1/-3 dB
Max. allowable input	10 V (DC + AC peak) (upper voltage which when applied to between input pins does not damage them)
Max. rated voltage to earth	30 V rms or 60 V DC (upper voltage which when applied to input channel casing or between input channels does not damage them)
Accessories	Conversion cable (2)

9318



9319

CONVERSION CABLE 9318
(to connect the clamp-on sensor to the 8940)

CONVERSION CABLE 9319
(to connect the 3273-50 to the 8940)



8940

Dimensions and mass:

Approx. 170W × 20H × 148D mm, approx. 300g

F/V UNIT 8940

Input	Number of channels: 2*1, Voltage input: BNC terminal *1 Input isolated from output, inter-channel isolation
Sensor connector terminal	Number of channels: 2 (for current measurement)*2 *2 Models that allow unit insertion up to a total of 4 channels: 8841, 8842, 8720
Compatible current sensors	9272-50, 9277, 9278, 9279, 3273-50
Measurement range	Frequency: 0.05Hz to 5kHz/ division, 11 ranges, 5(r/min) to 500(r/min)/ division, 5 ranges, P50 Hz (40 to 60 Hz), P60 Hz (50 to 70 Hz) Integration: 5 counts to 500 k counts/ division, Pulse duty ratio: 100 % f.s. Current: 5 mA to 100 A/ division, 10 ranges, linked to use with type of the clamp-on sensor, Voltage: 0.5 mV to 2 V/ division, 12 ranges, Max. allowable input: 30 V rms or 60 V DC, full-scale (f.s.) = 20 divisions, low-pass filter, 5/500/5k/ 100kHz or OFF, the measurement resolution is 1/80 of range
Max. sampling period	1μs (voltage, current)
Other functions	Voltage input pull-up: ON (10kΩ)/ OFF Input coupling: DC, GND, AC (voltage, current), DC (others)
Max. rated voltage to earth	30V rms or 60V DC (upper voltage which when applied to input channel casing or between input channels does not damage them)
Accessories	None * Input cord and conversion cable optional

Dimensions and mass:

Approx. 170W × 20H × 148D mm, approx. 310g



8946

4ch ANALOG UNIT 8946

Inputs	Number of channels: 4, Terminal: Metallic BNC * Input isolated from output, inter-channel isolation
Measurement range	10 mV to 2 V/ division, 8 ranges, full-scale (f.s.) = 20 divisions, low-pass filter, 5/ 500/ 5 k/ 50 kHz; the measurement resolution is 1/80 of range * When used in 8841
Maximum sampling rate	1 MS/s (simultaneous sampling of four channels)
Accuracy	DC amplitude: ±0.5 % f.s. Zero-position: ±0.15 % f.s.
Zero-position	-50 % to 150 %, 1 % step * With zero-adjustment function
Frequency characteristics	DC to 100 kHz ±3 dB
Input resistance and capacitance	1 MΩ, 15 pF approx. (at C 100 kHz)
Input coupling	DC, GND
Max. allowable input	30 V rms or 60 V DC (upper voltage which when applied to between input pins does not damage them)
Max. rated voltage to earth	30 V rms or 60 V DC (upper voltage which when applied to input channel casing or between input channels does not damage them)
Accessories	None * Input cord optional

*Not compatible with Model 8826

Dimensions and mass:

Approx. 170W × 20H × 148D mm, approx. 310g



8947

CHARGE UNIT 8947

Input	Number of channels: 2 Measurement objects can be selected individually for each channel. Full isolation between inputs, and between inputs and recorder. Common GND for voltage input and charge input channels. Voltage and pre-amplifier internal inputs: BNC terminals (With voltage input: input resistance, 1MΩ; input capacitance, less than 200 pF) Charge input: miniature connector (#10-32 UNF)
Suitable converters	Charge input: piezoelectric charge output acceleration pickup sensors, Internal pre-amplifier input: acceleration pickup sensors with built-in pre-amplifier
Measurement ranges	50m (m/s ²)/DIV to 10 k (m/s ²)/DIV, 12 ranges×6 types, the measurement resolution is 1/80 to 1/32 of range (changes according to measurement sensitivity) Measurement sensitivity: 0.1 to 10pC / (m/s ²), Pre-amplifier internal input measurement sensitivity: 0.1 to 10mV/ (m/s ²), Amplitude accuracy: ±2 % f.s., Frequency characteristics: 1 to 50 kHz +1/ -3 dB, Low-pass filter: 500 / 5kHz, Pre-amplifier driving power supply: 2mA ±20%, +15V ±5%, Highest input charge : ±500pC (high sensitivity side 6 ranges), ±50000 pC (low sensitivity side 6 ranges)
Measurement ranges	500μV to 2V/DIV, 12 ranges, the measurement resolution is 1/80 to 1/32 of range (changes according to measurement sensitivity) Voltage input (BNC terminal) DC amplitude accuracy: ±0.4% f.s., Frequency characteristics: DC to 400kHz +1/ -3 dB, Low-pass filter: 5 / 500 / 5k/ 100kHz, Input coupling: DC, AC, GND, Max. allowable input: 30V rms or 60V DC
Maximum sampling rate	1 MS/s (simultaneous sampling of two channels)
Max. rated voltage to earth	30V rms or 60V DC (upper voltage which when applied to input channel casing or between input channels does not damage them)
Accessories	None * Input cord optional

MEMORY HiCORDER

Common options for 8800 series

*Designated products are not CE-Mark compliant

Note: Product names appearing herein are trademarks or registered trademarks of the various companies.

Logic Signal Measurement



LOGIC PROBE

9321(9321-01)
4-channel isolated, on/off detection of AC/DC voltage

LOGIC PROBE

9320(9320-01)
4-channels, on/off detection of voltage/contact signal



CONVERSION CABLE 9323

for 9320/9321-8807/8808

Storage Media



PC CARD 128 MB 9726
PC CARD 256 MB 9727
PC CARD 512 MB 9728
PC CARD 1GB 9729

PC Communication



RS-232C CARD 9557
(compliance with the PCMCIA Standard)



GP-IB CARD 9558
(compliance with the PCMCIA Standard) * With a GP-IB cable, cord length : 2m (6.6 feet)

WAVE PROCESSOR 9335

software required to convert the binary file to CSV text file, to remote control with Windows 95/ 98/ NT 4.0 /Me/ 2000/ XP/Vista



Instrument

MEMORY BOARD 9608

Expands instrument memory by 4x
Must specify when ordering; not user installable.
(8841, 42 only)

Case



CARRYING CASE 9397-01
(for 8841 and 8855)
CARRYING CASE 9349
(for 8842 only)
with casters for convenient transportation.

DC Power Supply



DC POWER ADAPTER 9433
Supplies operating power in the range 10 to 28 V DC.
(8841 and 8842)

High-voltage input



DIFFERENTIAL PROBE 9322
for up to 2 kV DC, 1 kV AC



POWER CORD 9324
for logic terminal

POWER CORD 9325
for 8940 sensor terminal



AC ADAPTER 9418-15
for 9322



POWER CORD 9248
for 9687(8860-50/8861-50)

Input Modules



Various input modules

Install by inserting into the instrument
Can be replaced by user

ANALOG UNIT	8936
VOLTAGE/TEMPERATURE UNIT	8937
FFT ANALOG UNIT	8938
STRAIN UNIT	8939
F/V UNIT	8940
4ch ANALOG UNIT	8946
CHARGE UNIT	8947



CONNECTION CORD 9197
for high voltage (up to 500V)



CONNECTION CORD 9198
for low voltage (up to 300V)
(9332 only)



10:1 PROBE 9665
Max. Input Voltage 1 kV rms. (to 1 MHz)



100:1 PROBE 9666
Max. Input Voltage 5 kV peakV (to 1 MHz)

Current Measurement, other options



CLAMP ON PROBE 9018-50
Input from 10 to 500 A
40 Hz to 3 kHz for 0.2 V AC output. BNC terminal



CLAMP ON PROBE *9132-10
Input from 20 to 1000 A
40 Hz to 1 kHz for 0.2 V AC output. BNC terminal



AC/DC CURRENT SENSOR 9709
DC to 100 kHz
500A rated 2V/500A output
Ø 36 mm core jaw dia.

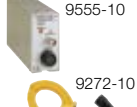

CLAMP ON SENSOR 9272-10
Enables observation of distorted AC current waveforms. Input selectable 20/200 A, 5 to 10 kHz for 2 VAC out
Note : Can only be used in combination with the SENSOR UNIT 9555 or F/V UNIT 8940 .

CONVERSION CABLE 9318

Connects 9277 to 9279 clamp-on sensors to F/V UNIT 8940.



UNIVERSAL CLAMP ON CT 9277
Observe waveforms from DC to distorted AC. Input up to 20 A, DC to 100 kHz for 2 VAC out

UNIVERSAL CLAMP ON CT 9278
Observe waveforms from DC to distorted AC. Input up to 200 A, DC to 100 kHz for 2 VAC out

UNIVERSAL CLAMP ON CT *9279
Observe waveforms from DC to distorted AC. Input up to 500 A, DC to 20 kHz for 2 VAC out
Note : Can only be used in combination with the SENSOR UNIT 9555 or F/V UNIT 8940 .

SENSOR UNIT 9555-10

Used together with 9272-10, 9277 to 9279 clamp-on sensors. Power supply unit.



PT *9303
Insulation transformer, 400 V or 200 V AC input, 10 V AC output, for AC power line measurement.



PAPER WINDER *220H
Paper width 70 ~ 220 mm
AC100V



CONVERSION ADAPTER 9199
Banana-to-BNC, use to connect to BNC terminal on Input Module



*CT-101A LINE SPLITTER
For 100V/15A, convenient for measuring 100 VAC line current with clamp-on probe



CONNECTION CORD 9217
Insulation BNC-to-insulation BNC, use to connect to insulation-BNC terminal on Input Module



CONNECTION CORD *9165
Metal BNC-to-metal BNC, use to connect to metal-BNC terminal on Input Module

POWER SUPPLY 3269/3272



CONVERSION CABLE 9319
Connects 3273, 3273-50 to 8940 F/V UNIT.

CLAMP ON PROBE 3273-50/3276

Wide (DC to 50 MHz/100 MHz) range, mA-level to 50 A peak current. Requires power from 3272 or 3269 or F/V UNIT 8940.

CLAMP ON PROBE 3274/3275

Wide (DC to 10 MHz) range, mA-level to 500 A rms current. Requires power from 3272 or 3269 only and requires scaling operations

MEMORY HiCORDER 8855

8ch high-speed isolated inputs of 20MS/s, Max. 512 M words long storage memory

- Maximum 8 analog channels and 16 logic channels
- 20MS/s, 8ch 12-bit high-speed isolated Input (8950/8951/8952)
- 1MS/s, 8ch 16-bit HIGH RESOLUTION Input (8953-10)
- Max. 512 M words long storage memory
- Zoom and scroll functions providing enlarged and compressed displays
- Standard LAN/SCSI interface

SPECIFICATIONS	
Measurement ranges using 8950 ANALOG UNIT /option	5 mV to 20 V/division, 12 ranges (20 division f.s.) resolution: 1/100 of range
Frequency band	DC to 10 MHz \pm 3dB Sampling speed max.20MS/s
Time axis at memory function	5 μ s to 5 minutes/division, 24 ranges (1 division =100 samples)
Functions	Memory, Recorder (Included X-Y), Rec & Memory, FFT/function
Number of input channels	8 analog channels plus 16 logic channels (analog inputs are isolated up to 370V)
Memory capacity	4M words/channel (Total 32MW) Max.64M words/channel (Total 512MW)(Option)
Data storage	FDD \times 1, Type-II PC card \times 1; PC CARD 9626-9729 (HDD \times 1/option)
Interfaces	LAN, SCSI, GP-IB or RS-232C (Option, use PC card)
Display and recording	10.4 inch TFT color LCD (option; 216mm \times 30m, roll type thermal paper)
Other functions	Scaling, Waveform judgment, Waveform processing calculations, Waveform parameter calculations, Memory segmentation, Waveform zoom display, Clock, Cursor readout, Comment entry, etc.
Power supply	100 to 240V AC 50/60 Hz Max. 180VA
Dimensions, mass	275W \times 285H \times 170D mm, 6.3kg
Accessories	Power cord(1), PC card protector(1) Input cord label(1), Wave viewer software(1)

OPTIONS

(The 8855 cannot be used alone. Measurement requires optional input unit or similar peripheral.)

●Options (Factory fitted)

PRINTER UNIT	8994
MEMORY BOARD (96MW)	9645
MEMORY BOARD (512MW)	9645-01
HD UNIT (20GB)	9663

●Options

ANALOG UNIT	8950	LOGIC PROBE	9321-01
VOLTAGE/CURRENT UNIT	8951	LAN COMMUNICATOR	9333
DC/RMS UNIT	8952	WAVE PROCESSOR	9335
HIGH RESOLUTION UNIT	8953-10	CARRYING CASE	9397-01
VOLTAGE/TEMP UNIT	8954	RS-232C CARD	9557
F/V UNIT	8955	GP-IB CARD	9558
CONNECTION CORD (500V Max.)	9197	FUNCTION UP DISK	9549
CONNECTION CORD (300V Max.)	9198	LAN CABLE	9642
CONNECTION CORD (BNC-BNC)	9217	PC CARD 128 MB	9726
RECORDING PAPER (30m, 6 rolls /1set)	9231	PC CARD 256 MB	9727
DIFFERENTIAL PROBE (9418-15 is necessary)	9322	PC CARD 512 MB	9728
POWER CORD (for 8950/8953-9322)	9328	PC CARD 1 GB	9729
LOGIC PROBE	9327	CLAMP ON SENSORS (refer to p.42-45)	
		Other common options (refer to p.12)	

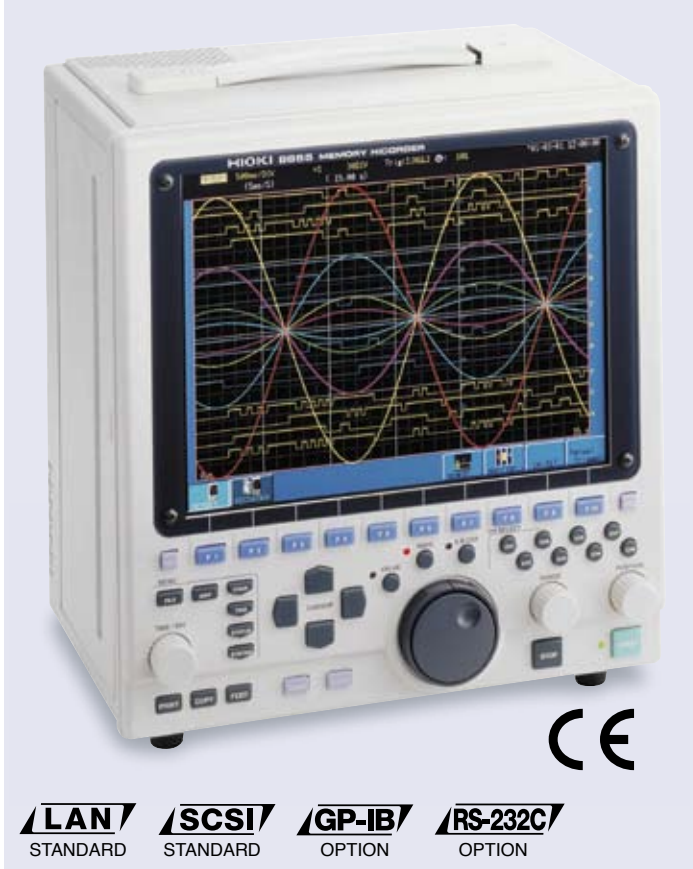

Recorders, Memory Recorders

- LAN**
STANDARD
- SCSI**
STANDARD
- GP-IB**
OPTION
- RS-232C**
OPTION

MEMORY BOARD 9645 (total 128 megawords)
Expands instrument memory by 4 times its original size. Specify upon order; factory installation only.

MEMORY BOARD 9645-01 (total 512 megawords)
Expands instrument memory by 16 times its original size. Specify upon order; factory installation only.

HD UNIT 9663
Specify upon order; factory installation only. (20 GB)

Input modules (8855 only)
Install or replace simply by inserting the module into the base unit
Note: Input cords are not provided. Please purchase the appropriate input cord for the probe type and application separately.

ANALOG UNIT	8950
VOLTAGE/CURRENT UNIT	8951
DC/RMS UNIT	8952
HIGH RESOLUTION UNIT	8953-10
VOLTAGE/TEMP UNIT	8954
F/V UNIT	8955

FUNCTION UP DISK 9549
Voltage, current, and power waveforms on the secondary side of an inverter

By installing the power monitor function in the MEMORY HiCORDER 8855, you can monitor power transient waveforms and view power trend graphs. Use of this function requires the optional FUNCTION UP DISK 9549, which is sold separately

Logic input

LOGIC PROBE 9327
4 channels, ON/OFF detection of voltage/contact signals (high-speed type for use with the 8855)

LOGIC PROBE 9321-01
4 isolated channels, ON/OFF detection of AC/DC voltage (small terminal-type for use with the 8855, 8807-01, and 8808-01)

ADAPTER CABLE 9323
(Terminal conversion cable for connecting the all-purpose LOGIC PROBE 9321 and the 8855 when terminals do not match.)

MEMORY HiCORDER | 8807-01 | 8808-01

New concept incorporating detachable printer, B5-sized handy recorder

- B5 book-sized, compact, and handy high-speed recorders
- 2 analog channels (8807-01) 4 analog channels (8808-01) isolated inputs (with 8 logic)
- PC card slot, 4-way power supply, and powerful trigger functions



SPECIFICATIONS

Measurement ranges	10 mV to 100 V*/division, 13 ranges (10 division f.s.), resolution: 1/160 of range, *1 100 V/division excludes the RMS & memory recorder functions
Frequency band	DC to 50 kHz, ±3 dB
Time axis at memory function	200µs to 5 minutes/division, 19 ranges (1 division =80 samples)
Functions	Memory recorder, Recorder, RMS & memory recorder (50/60 Hz or DC only)
Number of input channels	8807-01: fixed input section, 2 analog*2 +8 logic 8808-01: fixed input section, 4 analog*2 +8 logic *2 analog inputs are isolated up to 450V
Memory capacity	(analog 12 bits+ logic 4 bits)×256 k words*/channel * using CH1
Data storage	PCMCIA Type-II PC card ×1 PC CARD 9726-9729
Interfaces	RS-232C, Printer (PRINTER UNIT 8992 can be connected)
Recording and display	112 mm×18 m, roll type thermal paper, Recording speed: 10 mm/s (using AC adapter), 5 mm/s (using batteries), 5.7-inch STN color LCD
Power supply	AC ADAPTER 9418-15, LR6 (AA)×6 (Continuous use 1 hour, LR6 batteries cannot be used with PRINTER UNIT 8992), BATTERY PACK (Continuous use 3 hours) 9447, 12V DC Car battery
Dimensions, mass	203W×170H×52D mm (printer detached) 280W×170H×52D mm (printer attached) 8807-01: 1.1 kg (printer detached), 1.5 kg (printer attached) 8808-01: 1.2 kg (printer detached), 1.6 kg (printer attached)
Accessories	LR6 (AA) Alkaline batteries(6), Alkaline battery box(1), Shoulder belt(1), Wave viewer software(1)

OPTIONS

(The 8807-01 & 8808-01 cannot be used alone. Measurement requires optional INPUT CORD or similar peripheral.)

PRINTER UNIT (print size 100 mm width)	8992
RECORDING PAPER (18m, 10 rolls /1 set)	9234
LOGIC PROBE (refer to p.12)	9320-01
LOGIC PROBE (refer to p.12)	9321-01
CONVERSION CABLE	9323
CARRYING CASE (soft)	9391
CARRYING CASE (hard)	9648
AC ADAPTER (universal 100 to 240VAC, 12VDC/2.5A output)	9418-15
BATTERY PACK (7.2V, 2400 mAh, recharging with the 9418-15)	9447
RS-232C CABLE (mini DIN 9-pin to Dsub 9-pin, 1.5 m)	9612
CLAMP ON SENSORS (refer to p.42-45)	
WAVE PROCESSOR	9335
CHARGE STAND	9643
Other common options (refer to p.12)	

*Note: An input cord is not supplied with the 8807-01 & 8808-01. Requires the 9197 or 9198

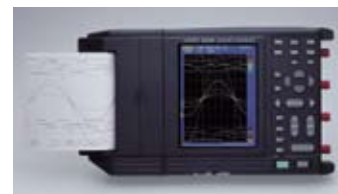

MEMORY HiCORDER | 8807-51 | 8808-51

Instantaneous Analysis and Long-term Recording of Harmonic Waves for Maintenance of Commercial Power Systems

Instantaneous harmonic analysis

- Measure harmonics up to 40 orders from the fundamental wave
- Analysis display includes RMS value, content factor, phase angle, active power, and power phase angle for each order of harmonics (numeric and graphic display)
- Analysis display of total RMS value, total distortion, active/reactive/apparent power, and power factor (numeric display)
- Bar graph and numeric data display
- Power phase angle can be displayed as a vector

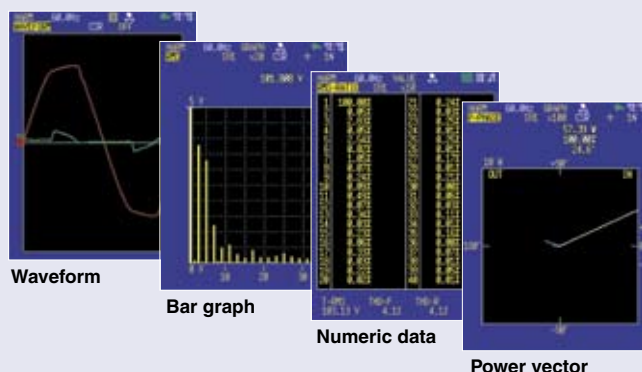

MEMORY HiCORDER | 8870-20

Anytime and Anywhere! Easy-to-Use Memory Recorder that Fits in the Palm of Your Hand

- Compact but powerful 2-channel recorder with 1MS/s sampling
- Highly intuitive user interface
- Brilliant wide screen QVGA-TFT display



Japanese Version

Recorders, Memory Recorders

SPECIFICATIONS

Measurement ranges (10div full scale)	10mV/div to 50V/div (12 ranges), Resolution: 1/100 of range Max. input voltage 400V DC
Frequency band	DC to 50kHz (-3dB)
Time axis range	100 μ s/div to 5min.div (5 ranges), Resolution: 100 points/div Zoom: $\times 2$ to $\times 10$ (3 steps), Compression: $\times 1/2$ to $\times 1/1000$ (9 steps)
Measurement function	Memory recorder
Number of channels	Analog 2ch + Logic 4ch (isolated between analog channels)
Memory capacity	2MW/ch, 12-bit
External memory	CF card slot (1), TYPE I, 1GB max.
Display	4.3" WQVGA-TFT color LCD (480 x 272 dots)
Interface	USB 2.0
Functions	Numeric calculations, Cursor measurement, Scaling, Screen copy, Gauge display, Waveform/setting backup, Auto save, Numeric display (instantaneous or RMS)
Power supply	AC adapter 9786 (100 to 240V AC, 50/60Hz) Battery pack (option) 10 to 16V DC
Dimensions, mass	176W x 101H x 41D mm, 550g
Accessories	AC adapter 9786 (1), Strap (1), USB cable (1), 8870 wave processor (1)

OPTIONS

CONNECTION CORD	9197	PC CARD 128MB	9726
CONNECTION CORD	9198	PC CARD 256MB	9727
LOGIC PROBE	9320-01	PC CARD 512MB	9728
LOGIC PROBE	9321-01	PC CARD 1GB	9729
CONVERSION CABLE	9323	CARRYING CASE	9782
DIFFERENTIAL PROBE	9322	CLAMP ON SENSORS (refer to p.42-45)	

(9418-15 is necessary)



WAVE COMPARATOR 8730-10 | 8731-10

A MEMORY HiCORDER geared for the production line

- Easy installation into production lines for high speed measurement and assessment
- Compare the signals of manufactured components and devices with a memorized reference signal to conduct PASS/FAIL evaluations on a waveform level
- 8730-10: 1ch input/comparison 8731-10: 2ch input/2ch simultaneous comparison
- Connect to a PC via LAN for networking capabilities

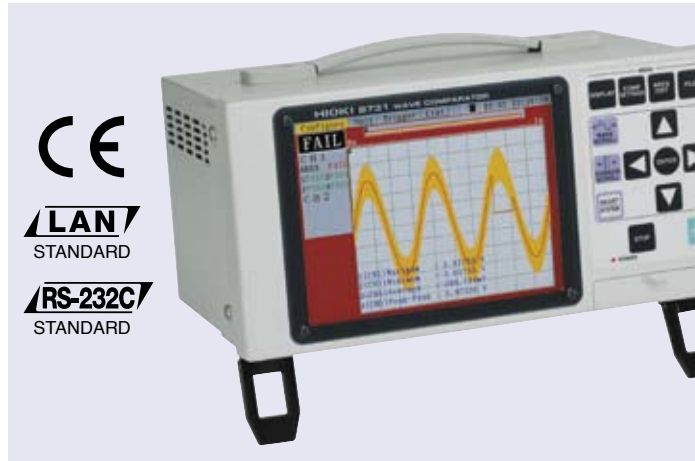

SPECIFICATIONS

Measurement ranges	100 mV to 5 V/division, 6 ranges (10 division f.s.) resolution: 1/160 of range
Frequency characteristic	DC to 400 kHz ±3 dB
Number of input channels	8730-10: Analog 1 channel 8731-10: Analog 2 channels
Memory capacity	12bits×50 k words/ch
Time axis	100µs to 5 minutes/division, 20 settings (1 division=100 samples) external sampling (up to 1 kHz, minimum sampling period 1 ms)
Measurement functions	Memory recorder with waveform evaluation function. Reference area waveform evaluation X-Y Measurement function Waveform parameter calculation Waveform processing calculation
Data storage	PC card Type II slot
Interfaces	RS-232C LAN (10BASE-T) External I/O
Display	7.2-inch STN color LCD
Power supply	100 to 240 V AC (50/60 Hz)
Dimensions, mass	8730-10:288W×144H×190D mm, 3.6kg 8731-10:288W×144H×190D mm, 3.7kg
Accessories	Power cord(1), Wave viewer software(1)

OPTIONS

LAN COMMUNICATOR	9333
WAVE PROCESSOR	9335
PC CARD 128M	9726
PC CARD 256M	9727
PC CARD 512M	9728
PC CARD 1GB	9729
LAN CABLE	9642

- <Combined with>
1. Sensors
 2. Instruments with analog output
 3. Generators

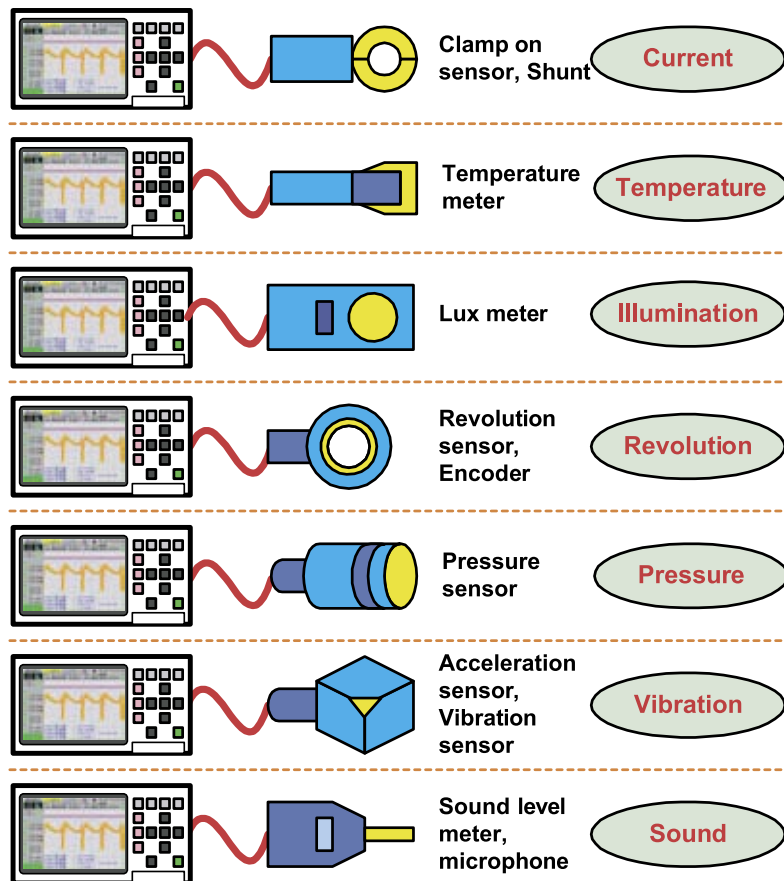

Welding Current

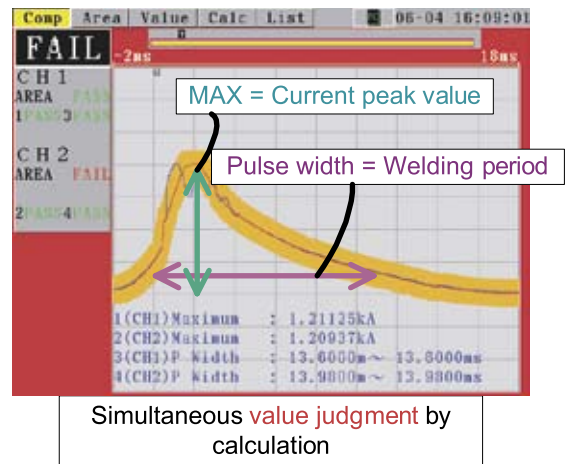

Layer Short Test



Layer short

MEMORY HILOGGER | 8423

Fast 10-ms Sampling. Up to 600 Channels Data Logging

- Capture data with 15 to a maximum of 600 channels
- Send data to the PC in real time
- Isolated to sustain up to 600 V between modules and earth
- USB 2.0, LAN 100BASE-TX, Store to 1GB PC Card
- Simultaneous fast-and low-speed sampling allows for media storage space efficiency



Recorders, Memory Recorders



SPECIFICATIONS	
No. of connectable units	Maximum 8 units (total 120 channels), Bundle 8 Modules together to achieve a 120-channel System, Bundle 5 Systems together to enable a maximum of 600 channels of simultaneous recording
Measurement parameters Model 8948	Voltage : $\pm 150\text{mV}$ to $\pm 100\text{V}$, 1-5V f.s. 6 ranges, Max. resolution $5\mu\text{V}$ Temperature (thermocouples) : -200°C to 2000°C (depend on the sensor), 3 range (K, E, J, T, N, W (Wre5-26), R, S, B), Max. resolution 0.01°C Max. allowable input : DC 100V, Max. rated voltage between channels : 200 V DC, Max. rated voltage to earth : 600 V DC, AC
Measurement parameters Model 8949	Voltage : $\pm 150\text{mV}$ to $\pm 60\text{V}$, 1-5V f.s. 6 range, Max. resolution $5\mu\text{V}$ Temperature (thermocouples) : -200°C to 2000°C (depend on the sensor), 3 range (K, E, J, T, N, W (Wre5-26), R, S, B), Max. resolution 0.01°C Temperature (Resistance temperature sensor) : -200°C to 800°C , 3 range (Pt 100, JPt 100), Max. resolution 0.01°C Humidity : 100% rh f.s., 5.0 to 95.0% rh (use with the 9701), resolution 0.1% rh Max. allowable input : DC 60V, Max. rated voltage between channels : 120 V DC, Max. rated voltage to earth : 600 V DC, AC

Measurement parameters Model 8996	Totalized pulses : 0 to 1000M pulse, 1 range (No-voltage 'a' contact, open collector or voltage input), Max. resolution 1 pulse Rotation count : 0 to 5000/n (r/s) f.s. 1 range (No-voltage 'a' contact, open collector or voltage input), Resolution 1/n (r/s) Note: n = pulses per rotation (1 to 1,000) Digital input : ON/OFF digital signal Max. allowable input : DC 50V, Max. rated voltage between channels : 33V AC, 70V DC, Max. rated voltage to earth : 600 V DC, AC, (Upper limit voltage that does not cause damage when applied between CH-1 to CH-5 each channel and chassis, CH-6 to CH-10 each channel and chassis, CH-11 to CH-15 each channel and chassis, and between each UNITS), (common ground for CH-1 to CH-5, common ground for CH-6 to CH-10, common ground for CH-11 to CH-15)
Recording intervals	10ms to 1hr, 19 range (5s to 1hr when combined with humidity measurement), Dual sampling : Recording intervals can be specified for every input module (high-speed and low-speed)
Function	Measurement data are saved to the CF Card in real time, Trigger function, Digital filter (Input unit), Alarm output (use with the ALARM UNIT 8997), Data acquisition is controlled by the PC data acquisition program, FTP server function, HTTP server function
Interface	LAN : supports 100Base-TX, USB : Ver 2.0, mini-B receptacle, CF card slot
Power supply	Using the AC ADAPTER 9418-15 /20 VA (when connected with 8 units), 12V Battery (voltage may range from -20% to +30%, Please contact HIOKI for connection cord).
Dimensions & Mass	67 W \times 133 H \times 125D mm , 600 g (main unit 8423 only)



OPTIONS

VOLTAGE/TEMP UNIT	8948	PC CARD 256M	9727
UNIVERSAL UNIT	8949	PC CARD 512M	9728
HUMIDITY SENSOR	9701	PC CARD 1G	9729
DIGITAL/PULSE UNIT	8996	LAN CABLE	9642
ALARM UNIT	8997	AC ADAPTER	9418-15
CONNECTION CABLE	9683	Logger Utility	
PC CARD 128M	9726		

**Note: 8423 cannot operate alone. You must install one or more optional input modules in the unit. Thermocouples are not provided by HIOKI, and must be purchased from a separate vendor.*

MEMORY HILOGGER | 8420-51 | 21-51 | 22-51

All analog inputs fully isolated!
Voltage/temperature loggers with PC networking support

- 8420-51(8ch), 8421-51(16ch), 8422-51(32ch) All analog channels isolated.
- Temperature, voltage, humidity, cumulative pulses, rotations
- Max. 32-channel, 100ms high-speed multi-channel data collection
- Alarm output with 8993
- Attachable Printer and I/O Module
- Up to 16 HiLOGGERS can be connected and controlled via LAN.



8421-51



Recorders, Memory Recorders

8420-51/8421-51 SPECIFICATIONS

Input Channels	8420-51: Analog 8 channels isolated by Photo-MOS relays 8421-51: Analog 16 channels isolated by Photo-MOS relays Pulse Inputs 4ch, Logic Inputs 16ch (using the 8993)
Measurement objects	Thermocouple : K,E,J,T,N,W(WRe5-26),R,S, and B Platinum measurement resistance type : Pt-100 JPt-100 Analog voltage input : 100mV,1V,10V,100V and 1-5V f.s.
Recording interval	100ms to 1hour (5 sec. to 1 hour for humidity measurement)
A/D resolution	16 bits
Memory capacity	Internal : 16MW DRAM (32MB) External : 9726-9729 PC CARD
Interfaces	RS-232C, LAN (10Base-T Ethernet connectors) Printer (8992), DIGITAL I/O UNIT (8993)
Display and Recording	5.7-inch STN color LCD, Printer 8992 (Option) 112 mm×18 m, roll type thermal paper, Recording speed: 2 mm/s
Function	Waveform compression and magnification, Event search, Waveform scroll, cursor measurement, scaling, automatic save, start condition retention, setting save, comment entry, automatic set up, numerical calculation
Power supply	AC ADAPTER 9418-15, BATTERY PACK 9447, 12V DC Car battery
Dimensions, mass	234W×170H×52D mm 1.4kg (instrument only) 310W×170H×52D mm 1.7kg (with printer) 302W×170H×52D mm 1.7kg (with Digital I/O Unit)
Accessories	AC ADAPTER 9418-15(1), Terminal Cover(1), Screwdriver(1), Wave viewer software(1)

8422-51 SPECIFICATIONS

Input Channels	8422-51: Analog 32 channels isolated by Photo-MOS relays Pulse Inputs 4ch, Logic Inputs 16ch (using the 8993)
Measurement objects	Thermocouple : K,E,J,T,N,W(WRe5-26),R,S, and B Analog voltage input : 100mV,1V,10V,100V and 1-5V f.s.
Recording interval	100ms to 1hour (16ch) (200 ms to 1 hour : 17 ch and over)
A/D resolution	16 bits
Memory capacity	Internal : 16MW DRAM (32MB) External : 9726-9729 PC CARD
Interfaces	RS-232C, LAN (10Base-T Ethernet connectors) Printer (8992), DIGITAL I/O UNIT (8993)
Display and Recording	5.7-inch STN color LCD, Printer 8992 (Option) 112 mm×18 m, roll type thermal paper, Recording speed: 2 mm/s
Function	Waveform compression and magnification, Event search, Waveform scroll, cursor measurement, scaling, automatic save, start condition retention, setting save, comment entry, automatic set up, numerical calculation
Power supply	AC ADAPTER 9418-15, BATTERY PACK 9447, 12V DC Car battery
Dimensions, mass	234W×170H×52D mm 1.4kg (instrument only) 310W×170H×52D mm 1.7kg (with printer) 302W×170H×52D mm 1.7kg (with Digital I/O Unit)
Accessories	AC ADAPTER 9418-15(1), Terminal Cover(1), Screwdriver(1), Wave viewer software(1)

OPTIONS

PRINTER UNIT (print size 100 mm width)	8992	CONNECTION CORD (for pulse Input)	9641
DIGITAL I/O UNIT	8993	LAN CABLE	9642
RECORDING PAPER (18m, 10 rolls /1 set)	9234	CHARGE STAND	9643
LOGGER COMMUNICATOR (refer to P.19)	9334	CARRYING CASE	9648
AC ADAPTER(100 to 240 V AC, 12 V DC/2.5 A output)	9418-15	PROTECTIVE CASE (Basic water-resistance)	9649
BATTERY PACK(7.2 V, 2400 mAh, recharging with the 9418-15)	9447	FIXED STAND	9652-01
RS-232C CABLE(mini DIN 9-pin to Dsub 9-pin, 1.5 m cross)	9612	HUMIDITY SENSOR	9701
RS-232C CABLE(mini DIN 9-pin to Dsub 9-pin, 1.5 m straight)	9721	TERMINAL UNIT	9329
		PC CARD 128M	9726
		PC CARD 256M	9727
		PC CARD 512M	9728
		PC CARD 1GB	9729



*Note: An input cord is not supplied with the 8420-51, 8421-51 & 8422-51

LOGGER COMMUNICATOR (for 8420-51, 8421-51 and 8422-51)

9334

Program that enables data collection using Ethernet and data analysis in Windows

Real-Time Data Collection on a PC (TCP/IP Communications)

Supports Up to 16 HiLOGGERS

Data measured by the HiLOGGER can be transferred to the PC in real time.

SPECIFICATIONS

Compatible devices	MEMORY HiLOGGERS 8420-51, 8421-51 and 8422-51
Supplied Media	One CD-R
Operating environment	Computers running under Windows 95/98/Me or WindowsNT/2000/XP. CPU: Pentium (133 MHz) or later, 32-MB memory or more OS: Windows 95/98/Me or Windows NT 4.0 SP3 or later / 2000/XP.
Data transfer functions	<ul style="list-style-type: none"> Interface: Ethernet Number of units supported: 16 Location of memory data: data can be loaded into the unit's internal memory Real-time transfer: data can be loaded in real time (maximum file size: up to 200 MB), real-time load settings can be made using the remote control
Display functions	<ul style="list-style-type: none"> Waveform Display: displays acquired waveform data as images Real-time Display: displays real-time transfers as images and allows the time axis to be split Digital Value Display: displays waveform data as digital values, and allows images and digital values to be displayed simultaneously Cursor function: allows you to display the time and potential differences between cursors A and B, the time and electrical potential between each cursor, and the absolute and relative times Scroll function Maximum number of channels: 512 analog channels, 256 logic channels, and 64 pulse channels Data load format: real-time and memory Alarm Output Display
Storage function	<ul style="list-style-type: none"> Memory content: criteria settings and measurement data (binary and text formats)
Data conversion functions	<ul style="list-style-type: none"> Target data: all data or data between cursors A and B Data interval: simple interval, average value, absolute and maximum values, maximum and minimum values (can be selected when saving) Data conversion: can convert analog and pulse waveform data into numerical values and logic data into binary Data conversion format: CSV Conversion channel: can be selected when saving
Print functions	<ul style="list-style-type: none"> Target data: all data or data between cursors A and B Print format: waveforms and numerical values
Parameter calculation functions	<ul style="list-style-type: none"> Target data: all data or data between cursors A and B Calculation items: average value, peak value, maximum value, maximum value time, minimum value, minimum value time, ON time, OFF time, number of times ON, number of times OFF, standard deviation, area
Other	<ul style="list-style-type: none"> Marking function: inserts an event marker at the start of measurement Search functions: Select from event marker, date (absolute and relative time), trigger, maximum, minimum, peak, valley, alarm, level, window, or volume of change

Recorders, Memory Recorders

MICRO HiCORDER | 8205-10 | 8206-10

Easy data recording as convenient as a simple tester, yet with broad functionality

- Record voltage and current variations simply with full line-up of optional clamp on sensors of up to 1000A
- Input levels can be monitored on the LCD like an analog display
- Built-in thermal printer for printing data such as time and amplitude axis



8205-10: SPECIFICATIONS

Measurement ranges	DC / AC Voltage: 0.1V to 500V f.s., 12 ranges AC Current: 10A to 1000A f.s., 7 ranges (using CLAMP ON SENSOR / option)
Sampling period	10ms
Frequency band	20Hz to 30kHz, ±3 dB
Paper feed speed	20cm/minute to 2cm/hour, 5 ranges
Number of input channels	Voltage or Current, 1 channel
Accuracy	Voltage: ±2% f.s., Current: ±4% f.s. (using 9651 CLAMP ON SENSOR / option)
Power supply	100 to 240V AC (50/60 Hz) or 9.5 to 14V DC, 2 way
Dimensions, mass	250W×122H×93.5D mm, 1.2 kg
Accessories	Power cord(1), Recording paper(1 roll), CONNECTION CORD 9257 (1), CARRYING CASE 9344(1)

8206-10: SPECIFICATIONS

Measurement ranges	AC Voltage: 100/ 200/ 500 V extended scale, 3 ranges AC Current: 10A to 1000A f.s., 7 ranges (using CLAMP ON SENSOR / option)
Sampling period	10 ms
Frequency band	30Hz to 30kHz, ±3dB
Paper feed speed	60 cm/hour to 2 cm/hour, 5 ranges
Number of input channels	Voltage and Current, 2 channels alternate recording
Accuracy	Voltage: ±2% f.s., Current: ±4 % f.s. (using 9651 CLAMP ON SENSOR / option)
Power supply	100 to 240 V AC (50/60 Hz) or 9.5 to 14 V DC, 2 way
Dimensions, mass	250W×122H×93.5D mm, 1.2kg
Accessories	Power cord(1), Recording paper(1 roll), CONNECTION CORD 9257(1), CARRYING CASE 9344 (1)



OPTIONS

- CLAMP ON SENSOR 9650 (for 8205-10, 8206-10, 100A f.s., 40Hz~1kHz, 3m length)
- CLAMP ON SENSOR 9651 (for 8205-10, 8206-10, 500A f.s., 40Hz~1kHz, 3m length)
- CLAMP ON SENSOR 9668 (for 8205-10, 8206-10, 1000A f.s., 40Hz~1kHz, 3m length)
- RECORDING PAPER (15m, 10rolls / 1 set) 9235
- RECORDING PAPER (Climate-resistant, 15m, 10rolls/1set) 9236-01
- CONNECTION CORD (for 8205-10 only) 9326
- 220H PAPER WINDER (refer to p.12)

NOISE HILOGGER 3145-20

New

Measures the noise Current levels and frequencies on telecom, power and grounding lines

- Easily view the noise current level in each band
- Record noise level variations over time in each band
- Measures noise current on earth lines easily
- Hard to detect One-Shot noise with a spectrum analyzer or oscilloscope, are reliably captured
- Data can be automatically saved to a PC Card, continuous long-term recording

CE

LAN STANDARD

RS-232C STANDARD

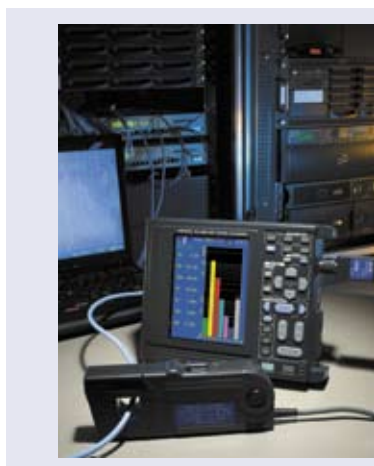

Recorders, Memory Recorders

3145-20 SPECIFICATIONS

Input terminal	BNC (max. input voltage 5V peak), 5kHz to 100MHz (-3dB)
Measurement ranges	[Current] 0.2mA, 2A, 20A (used with the 9754) [Voltage] 10mV, 100mV, 1V
Band Path Filter characteristics	Center frequency: 15k, 70k, 250k, 1M, 5M, 20M, 60MHz, 7 BPFs separates noise (fixed), measuring the peak value in each band
Monitor function	Displays real-time peak-to-peak values in each frequency band on level meters, Refresh interval: 100ms
Logging function	Records maximum peak-to-peak values in each frequency band at the specified recording interval to internal memory (16 days at 1sec interval to 2.5 years at 60sec interval)
Recording interval	1, 2, 5, 10, 20, 30, 60 sec
Functions	Displays a time-series graph, Alarm function, Event mark function, External trigger
Interface	LAN, RS-232C
Power consumption	AC ADAPTER 9418-15 /30VA max., BATTERY PACK 9447 / Continuous use 1hour (20VA max.)
Dimensions and mass	203 W × 170 H × 52D mm, 1.2kg
Accessories	AC ADAPTER 9418-15 × 1, Carrying case × 1, Strap × 1, Ferrite clamp × 3, CD-R (DATA VIEWER for 3145 software, Communication commands manual, or other) × 1, Operating manual × 1, Operating guide × 1

9754 SPECIFICATIONS

Band width	1kHz to 100MHz (-3dB)
Rated current	AC 10A (15A peak)
Amplitude accuracy	±3.0% rdg, ±0.001% f.s. (f.s. =10A, f=15kHz, with conductor centered in clamp)
Measurable conductor diameter	up to f20mm
Max. rated voltage to earth	CAT II 600V, CAT III 300V (insulated conductor)
Dimensions and mass	176 W × 69H × 27D mm, 450g, Cord length 2m

OPTIONS

CLAMP ON NOISE SENSOR	9754 (required)
AC ADAPTER	9418-15
BATTERY PACK	9447
CHARGE STAND	9643
RS-232C CABLE	9721
RS-232C CABLE	9612
LAN CABLE	9642
PC CARD 128M	9726
PC CARD 256M	9727
PC CARD 512M	9728
PC CARD 1G	9729

NOISE SEARCH TESTER 3144-20

Identify noise Voltage in communication and power lines

3144-20 SPECIFICATIONS

Input unit configuration	9741dedicated input terminal, BNC input terminal (9741 takes priority)
Frequency range band	500Hz to 30MHz, separated into 7ranges (-3 dB) 500Hz to 3kHz (1 kHz range) / 7.5kHz to 22.5kHz (15kHz range) / 35kHz to 105kHz (70kHz range) / 125kHz to 375kHz (250kHz range) / 0.5MHz to 1.5MHz (1MHz range) / 1.5MHz to 4.5kHz (3MHz range) / 10MHz to 30MHz (20MHz range) / (BNC input 50Ω termination)
Detection method	RMS value conversion
Detection accuracy	500Hz to 1 MHz or less±1.5dBV 1MHz to 30 MHz±2.0dBV
Monitoring function	Display of measurement voltage level of each frequency range in levels on LCD (2.5dBV/SEG equivalent)
Logging function	Measurement data and time saved to internal memory according to specified recording interval
Recording interval	1/2/5/10/20/30 seconds 1/2/5/10/20/30/60 minutes
Output function	Wave monitoring (Output of input signal coming from 9741 or BNC input) Audible range monitoring (Output of detection signal envelope Earphone)
Power	AA-size alkaline batteries (LR6) ×6, DC9 V 500mA
Dimensions and mass	98W ×179H ×46D mm, 430g (excluding batteries)

3144-20

USB 1.1 STANDARD

CE



9741 SPECIFICATIONS

Sensor configuration	Electrostatic coupling non-contact voltage sensor
Frequency range	600Hz to 30MHz (-3dB)
Conductor dia	φ20mm
Dimensions and mass	62W ×158H ×40D mm, 260g

Power Measuring Instruments



Power Measuring Instruments Index

For high level performance



3193 **CE**
 DC, or Single-phase to 3-phase
 4-wire Wide-band up to 1 MHz
 6 ch-Direct/ Clamp input
 p.25



3194 **CE**
 Analysis station for Motor
 Evaluation Power, Harmonics,
 Rotation Speed, Torque,
 Converter efficiency
 p.25



3196 **CE**
 Power quality analyzer
 DC, or Single-phase to 3-phase
 4-wire
 Clamp input
 p.23



3197 **CE**
 Fully portable Power Quality
 Analyzer
 1P2W to 3P4W
 Clamp Input
 p.24



9624-50
 PQA- HIVEVIEW PRO
 Software application for 3196
 and 3197
 p.25

For use on production lines



3331 **CE**
 Single-phase to 3-phase 3-wire
 V,A,W,VA,var,integ., PF Phase
 angle, Hz Direct input only
 p.26



3332 **CE**
 Single-phase 2-wire V,A,W,VA,
 var,integ., PF Phase angle, Hz
 Direct input only
 p.26



3333/3333-01 **CE**
 High Accuracy ($\pm 0.1\%rdg. \pm$
 $0.1\% f.s.$)
 Maximum Cost Performance
 p.26



3334/3334-01 **CE**
 Wide Input Range
 DC, Single-phase 2-wire
 Bandwidth DC, 45 to 5kHz
 Basic accuracy $\pm 0.2\%$
 p.26

For managing power lines



3169-20/-21 **CE**
 Single-phase to 3-phase 4-wire
 V,A,W,VA,var,integ., PF, Hz
 Clamp input only
 p.22



9625
 POWER MEASUREMENT
 SUPPORT SOFTWARE
 for 3169-20/21
 p.22



3286-20 **CE**
 Clamp-On Power Meter
 V,A,W,VA,var, PF,Hz, Harmonics
 (V, A)
 p.51

CLAMP ON POWER HITESTER | 3169-20 | 3169-21

Offering a new approach to energy-related measurement such as energy conservation, ISO14001 testing, equipment diagnosis, and harmonics measurement.



CAT III 600V



RS-232C
STANDARD

True RMS

- From 1-phase 2-wire to 3-phase 4-wire systems
- 5 A to 5000 A range, PC card data storage
- Power recording for individual waveforms
- Simultaneous recording of demand values and harmonics
- D/A output with 3169-21



9661×2, 9669×2 (option)

Power Measuring Instruments

SPECIFICATIONS	
Measurement lines	Single-phase 2-wire, single-phase 3-wire, three-phase 3-wire, and three-phase 4-wire systems (50/60 Hz)
Measurement item	Voltage, Current, Active power, Reactive power, Apparent power, Power factor, Integrated value, Frequency, Harmonics
Measurement range	Voltage: 150 V to 600 V, 3 ranges Current (When using 9660): 5 A to 100 A, 4 ranges Current (When using 9661): 5 A to 500 A, 5 ranges Current (When using 9669): 100 A to 1 kA, 3 ranges Current (When using 9667): 500 A / 5 kA, 2 ranges Current (When using 9694): 0.5 A to 5 A, 3 ranges Power: 75 W to 9 MW, 108 combination patterns
Basic accuracy	±0.2% rdg, ±0.1% f.s. + Clamp accuracy (for active power)
Clamp sensor accuracy	9660 (rated for 100 A): ±0.3% rdg, ±0.02% f.s. 9661 (rated for 500 A): ±0.3% rdg, ±0.01% f.s. 9669 (rated for 1000 A): ±1.0% rdg, ±0.01% f.s. 9667 (rated for 5000 A): ±2.0% rdg, ±1.5 mV 9694 (rated for 5 A): ±0.3% rdg, ±0.02% f.s.
Frequency characteristic	Fundamental waveforms up to the 50th order ±3% f.s. + measurement accuracy
Other functions	PC card, RS-232C, D/A output (3169-21 only, 4 channels), External I/O
Power supply voltage rating	100 to 240 V AC, 50/60 Hz
Dimensions, mass	210W×160H×60D mm ±5 mm, 1.2 kg ±100 g (3169-20, 3169-21)
Accessories	Voltage cord set 9438-03 (1), Power cord (1), Input cord label (1), Operating manuals (2), CD-R (1), Connection cable 9441 (1) (for the 3169-21 only)

OPTIONS

- **Current measurement**
(The 3169-20/21 cannot be used alone. Measurement requires one or more optional clamp-on sensors.)
 - CLAMP ON SENSOR rated current 100 A AC 9660
 - CLAMP ON SENSOR rated current 500 A AC 9661
 - CLAMP ON SENSOR rated current 1000 A AC 9669
 - FLEXIBLE CLAMP ON SENSOR rated current 5000 A AC 9667
 - CLAMP ON SENSOR rated current 5 A AC 9694
 - CLAMP ON ADAPTER rated current 1500 A AC, output 150 A (10:1 ratio) 9290-10
 - AC ADAPTER (for the 9667, for America, Japan) 9445-02
 - AC ADAPTER (for the 9667, for Europe) 9445-03
- **Voltage measurement**
VOLTAGE CORD (Supplied as standard with 3169-20/-21) 9438-03
- **PC communication**
POWER MEASUREMENT SUPPORT SOFTWARE 9625
RS-232C CABLE for connection to PC 9612
PC CARD 128M 9726
PC CARD 256M 9727
PC CARD 512M 9728
- **Other options**
CARRYING CASE 9720-01
CONNECTION CABLE for external I/O, 2 m length 9440
CONNECTION CABLE (3169-21 standard), for D/A output, 2 m length 9441
- **Printer**
PRINTER 9442
AC ADAPTER for the 9442 PRINTER, EU type 9443-02
AC ADAPTER for the 9442 PRINTER, USA type 9443-03
RS-232C CABLE for connection to the 9442, 1.5 m length 9721
RECORDING PAPER 112 mm width×25 m, roll type, 10 rolls per set 1196



PRINTER 9442

Print method : Thermal serial dot printing
Paper width : 112 mm
Print speed : 52.5cps
Power supply : AC adapter 9443-02/03, or supplied nickel-metal hydride battery (approx. 3000 lines of printing when fully charged and used with the 9443-02/03)
Dimensions, mass : Approx. 160W×66.5H×17D mm, approx. 580g

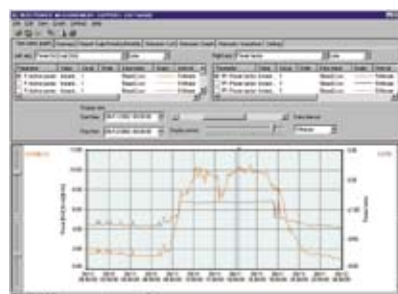

POWER MEASUREMENT SUPPORT SOFTWARE 9625

When purchasing the Printer 9442, make sure you also purchase the RS-232C cable 9721 and AC adapter 9443-02/03 so that you can connect it to the 3169-20/21.

POWER QUALITY ANALYZER | 3196

Monitor and record the quality of power to analyze the cause of trouble when it occurs !

Most complete instrument for power quality troubleshooting

- Measure Dips, Swells, Interruptions, Flicker, Transients
- Harmonic to the 50th order
- High frequency transient over voltage
- Detection and waveform display
- 4 current and 4 voltage channels
- 400Hz Fundamental wave
- GPS Synchronization

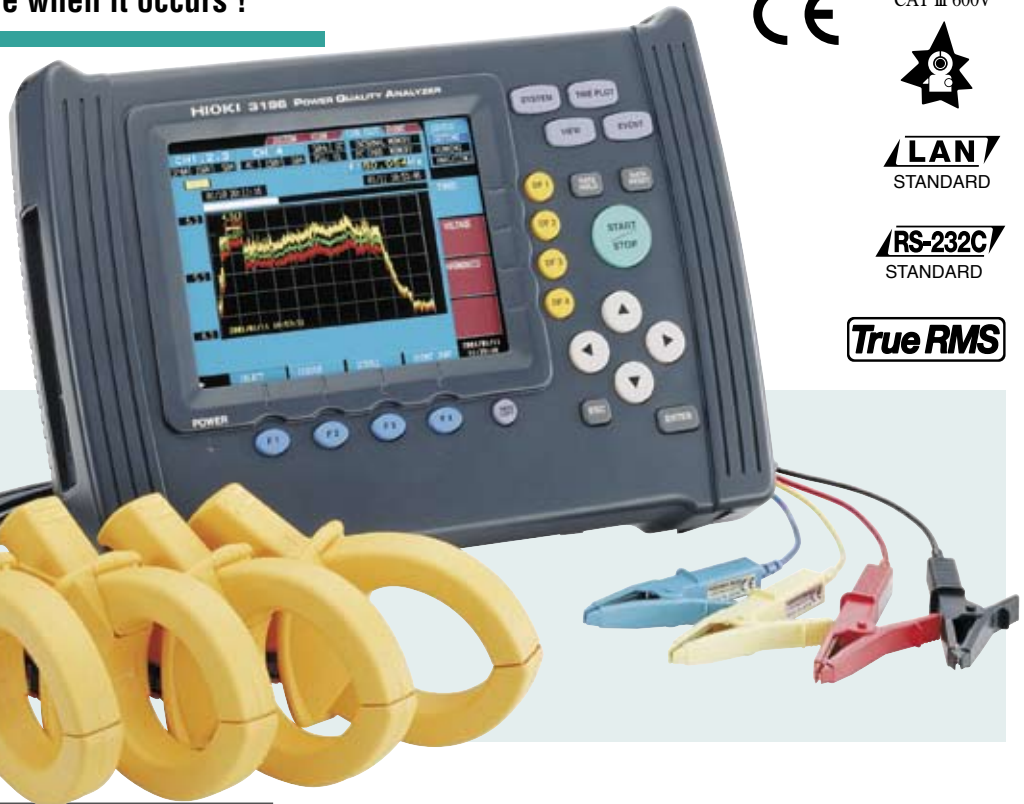

CAT III 600V



LAN STANDARD

RS-232C STANDARD

True RMS

9661x4 (option)

Power Measuring Instruments

SPECIFICATIONS

Measurement lines	Single-phase two-wires, Single-phase three-wires, Three-phase three-wires, Three-phase four-wires
Voltage range	ch1, ch2, ch3: 150/300/600V ch4: 60/150/300/600V(AC), 60/600V(DC)
Current range	9660: 50/100A, 9661:50/500A, 9667:500/5000A, 9669:1000A
Measurement Method	Transient overvoltage: 2MHz/s Arithmetic operation: 256points/cycle Harmonic/Inter-harmonic: 2048points/10cycles (for 50Hz) 2048points/12cycles (for 60Hz)
Measurement Function	1. Transient overvoltage 2. Voltage swell, Voltage dip, Voltage interruption 3. Frequency, Voltage, Current, Voltage/Current peak, Active/Reactive /Apparent power, Power factor, DPF 4. Voltage unbalance ratio, Current unbalance ratio 5. Harmonic voltage/current/power, Inter harmonic voltage/current, Harmonic voltage current phase angle, Total harmonic/inter harmonic distortion 6. IEC flicker[Pst, Plt], K factor / ΔV10(Japan) 7. EN-50160
Internal memory	13MB
Interface	PC card (Flash ATA card / up to 528 MB) RS-232C, LAN (10BASE-T), HTTP server function
Power supply	9458 AC adapter or 9459 battery pack
Dimensions, mass	298W×215H×67D mm, 2.0 kg
Accessories	Voltage cord (1set), 9458 AC adapter (1), Battery pack 9459 (1), strap (1), Down 96 (data download software)

OPTIONS

(The 3196 cannot be used alone. Measurement requires one or more optional sensors.)

● Current measurement	
CLAMP ON SENSOR rated current 100A AC	9660
CLAMP ON SENSOR rated current 500A AC	9661
CLAMP ON SENSOR rated current 1000A AC	9669
FLEXIBLE CLAMP ON SENSOR rated current 5000A AC	9667
CLAMP ON SENSOR rated current 5A AC	9694
CLAMP ON ADAPTER rated current 1500A AC, output 150A (10:1 ratio)	9290-10
AC ADAPTER (for the 9667, for America, Japan)	9445-02
AC ADAPTER (for the 9667, for Europe)	9445-03
● Voltage measurement	
VOLTAGE CORD (standard accessory)	9438-02
WIRING ADAPTER (3P3W)	9264-01
WIRING ADAPTER (3P4W)	9264-02
● PC communication	
PQA HiVIEW PRO (PC application software for advanced data processing)	9624-50
LAN CABLE (5m, with straight and crossover connectors)	9642
PC CARD 128 M	9726
PC CARD 256 M	9727
PC CARD 512 M	9728
● Other options	
AC ADAPTER (included)	9458
BATTERY PACK (included)	9459
CARRYING CASE (soft)	9339
CARRYING CASE (hard)	9340
● Printer	
PRINTER (with one roll of recording paper)	9670
AC ADAPTER (for 9670)	9671
BATTERY PACK (for 9670)	9672
BATTERY CHARGER (for 9672)	9673
RECORDING PAPER (80 mm×25 m, 4 rolls, for 9670)	9237
RS-232C CABLE (1.5 m, for printer connection)	9638



CLAMP ON SENSOR 9660
Current up to 100A
CLAMP ON SENSOR 9694
Current up to 5A AC



FLEXIBLE CLAMP-ON SENSOR 9667
Current up to 5000A AC Diameter up to 254mm Rogovski-type current sensor



CLAMP ON SENSOR 9661
Current up to 500A



CLAMP ON SENSOR 9669
Current up to 1000A

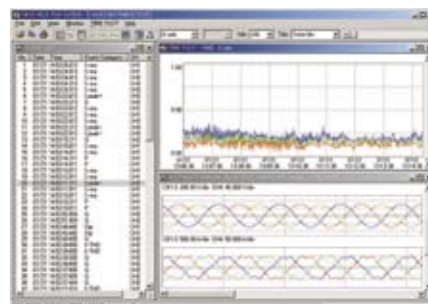

PQA-HiVIEW 9624-50
Model 9624-50 PQA-HiVIEW PRO software application is a program for analyzing binary codes stored on a PC card by Model 3196.

EN50160

POWER QUALITY ANALYZER | 3197

The Most Comprehensive Portable PQA on The Market

Catch Power Quality Problems on the Fly...

- Monitor for:
 - Inrush Current
 - Voltage Swells
 - Voltage Dips
 - Transient Overvoltage
 - Interruptions
- Measure and Record:
 - Power and Power Factor
 - Active/Reactive Energy
 - Demand
 - Load Changes (with graph display!)
 - Voltage and Current



USB 2.0
STANDARD
(for data transfer only)

True RMS



SPECIFICATIONS	
Measureable Circuits	1P2W/1P3W/3P3W2M/3P3W3M/3P4W/3P4W2.5E
Measurement Line Frequency	Auto-detect (50Hz/60Hz)
Voltage Range	600.0V
Current Range	Manually Switchable from 2 Range Sets According to Clamp Sensor 500.0mA/5.000A/50.00A/100.0A/500.0A/1.000kA/5.000kA
Measurement Function	1. Transient overvoltage 2. Voltage swell, Voltage dip, Voltage interruption 3. Frequency, Voltage, Current, Voltage/Current peak, Active/Reactive/Apparent power, Power factor, DPF 4. Voltage unbalance ratio 5. Harmonic voltage/current/power, Harmonic voltage-current phase angle, Total harmonic distortion 6. In rush currnt
Interval Settings	AUTO/1/5/10/15/30/60 minutes
Maximum Recordable Period	125 Days with internal non-volatile memory of 4MB - stored data will not be deleted upon power OFF; partition memory into 4 segments for maximum 31 days of recording each
Internal Memory	4MB
PC Interface	USB Ver.2.0 (for data transfer only)
Power supply	9418-15 AC Adapter or 9459 Battery Pack
Dimensions and Mass	128W x 246H x 63D mm, 1.2 kg with battery pack
Accessories	Voltage cords (4), BATTERY PACK (1), AC ADAPTER (1), USB Cable (1), Basic PC Software (1), Carrying Case (1), Strap (1)

OPTIONS	
CLAMP ON SENSOR 100A AC	9660
CLAMP ON SENSOR 500A AC	9661
FLEXIBLE CLAMP ON SENSOR 5000A AC	9667
CLAMP ON SENSOR 1000A AC	9669
CLAMP ON SENSOR 5A AC	9694
CLAMP ON SENSOR 50A AC	9695-02
CLAMP ON SENSOR 100A AC	9695-03
CONNECTION CORD (for the 9695-02/9695-03)	9219
CLAMP ON SENSOR 10A AC	9657-10
CLAMP ON SENSOR 10A AC	9675
VOLTAGE CORDS (bundled with standard 3197)	9438-05
BATTERY PACK (bundled with standard 3197)	9459
PQA HiVIEW PRO (PC application software)	9624-50
AC ADAPTER (for the 9667, for America, Japan)	9445-02
AC ADAPTER (for the 9667, for Europe)	9445-03



PQA-HiVIEW PRO | 9624-50



Basic PC Analysis of Model 3196 and 3197 Data

Viewer function

Use this function to display screens similar to those used for the 3196/3197.

Select from the **TIME PLOT screen** (voltage fluctuation, RMS fluctuation, harmonic fluctuation, inter-harmonic fluctuation), **event list screen**, **event data screen** (waveforms, vectors, DMM, harmonics, event details), **ΔV10 screen** (Japanese standard), or **settings screen**. In the TIME PLOT screen, and use the two cursors (A and B) to calculate waveforms within a specified interval.

Demand/integral power consumption function

Calculate demand and integral power consumption from TIME PLOT data for effective power.

Binary CSV format conversion function

Convert binary data into CSV format for event waveforms within the specified range in the TIME PLOT screen or event waveforms selected in the event waveform screen. Files saved in CSV format can be used with spreadsheet software on your PC.

Print function

Use this function in each screen to output reports to a printer connected to your PC.

ITIC curve display function

Make ITIC (CBEMA) curve analyses (limit curve) based on the power quality control standards of the U.S.A.

EN50160 display functions

(applicable standard is EN50160:1999)

Effectively evaluate and analyze the quality of power according to EU standards.

Downloading from LAN

Data (BINARY/TEXT/BMP) recorded on a PC card or the internal memory of the 3196 can be downloaded via LAN to a personal computer. (*This can be done without use of the freeware Down96. Measurement on the 3196 must be halted during download.)

Report generation function

Choose from 3 types of report generation settings to take care of all the troublesome reporting operations, and either send the data to a printer or save as a Rich Text file. (Automatic: Output basic items. Individual setting: Select any item for output. Detailed setting: Specify a time-series graph in details for output.)

Positive phase, negative phase, and zero phase function

Recalculate event data captured by 3P4W circuits, and display each component of the voltage/current of the positive phase, negative phase, and zero phase.

Measurement data is saved in binary format

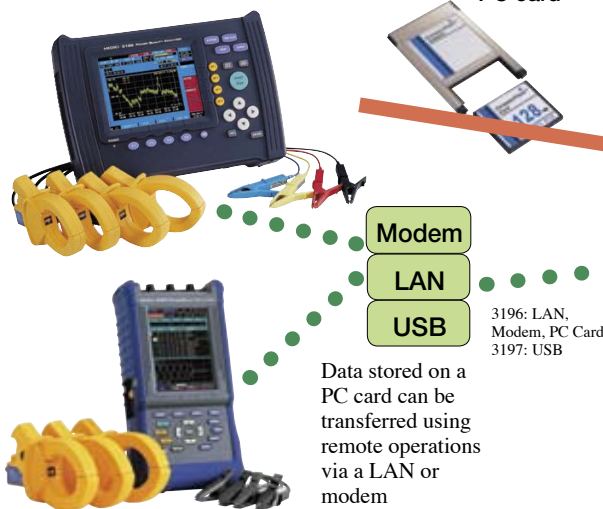

Data stored on a PC card can be transferred using remote operations via a LAN or modem

Data processing is quick and easy using the 9624-50 PQA-HiVIEW software

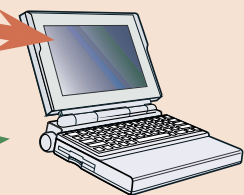

- Use it to create reports
- Use data converted to CSV format

Power Measuring Instruments

POWER HiTESTER | 3193

Wide spectrum power meter for comprehensive device assessment

CE

GP-IB STANDARD

RS-232C STANDARD

True RMS

**Note: 9600 to 9605 : factory installation only
*Certain Clamp-on sensors are not CE-mark compliant.
Please refer to p.44*

SPECIFICATIONS	
Measurement lines	Single-phase/two-wires to three-phase/four-wires (Through the use of various input units)
Measurement items	(When using 9600, 9601, 9602, optional) Voltage, current, voltage/current peak, effective/reactive/apparent power, power factor, phase, frequency, current/power integration, load rate, efficiency (When using 9603, optional) Voltage, torque, RPM, frequency, motor output (When using 9605, optional) Harmonic, waveform, voltage fluctuation / flicker measurement function
Measurement ranges	Voltage: 6.0000V to 1.0000kV (depends on use of the input unit) Current: 200.00mA to 500.00A (depends on use of the input unit) Power: Depends on combination of voltage and current ranges
Integration range	0 to ±999999 TAh/ TWh, (integration time up to 10000 hours)
Basic accuracy used with 9600 to 9602 Input unit	±0.1% rdg. ±0.1% f.s. (voltage, current, power, at 45 to 66Hz) Note: When used together with the 9270 to 9272, and 9277 to 9279, resulting accuracy is the sum of that indicated above and the accuracy of these clamp sensors.
Frequency characteristics	using with 9600: DC, 0.5Hz to 1MHz using with 9601: 5Hz to 100kHz using with 9602: DC, 0.5 Hz to 200 kHz (depends on the clamp accuracy)
Signal output	Analog level: Voltage, current, active power, 5V DC f.s. Waveform monitor: Voltage, current, 1V rms f.s. D/A output: Outputs 8 arbitrarily selected items, DC±5V f.s.
Other functions	6.4 inch TFT color LCD, RMS/MEAN rectification, FDD, GP-IB/RS-232C interface, scaling, averaging
Power supply	100/120/200/230 V AC (switched automatically), 50/60 Hz
Dimensions, mass	430W×150H×370D mm, 15 kg (with all options)
Accessories	Power cord (1), Connector for EXT I/O (1)

OPTIONS	
(The 3193 cannot be used alone. Measurement requires one or more input units.)	
AC/DC DIRECT INPUT UNIT	9600 PRINTER UNIT 9604
AC DIRECT INPUT UNIT	9601 HARMONIC / FLICKER MEASUREMENTS UNIT 9605
AC/DC CLAMP INPUT UNIT	*9602 CLAMP ON SENSOR 9277, 9278, 9279, 9709
EXTERNAL SIGNAL INPUT UNIT	9603 CLAMP ON ADAPTER 9290-10

POWER HiTESTER 3332

Measure very low effective power, for stand-by mode of home use equipment

- Ultra high-sensitive measurement, for use to measure the effective power of equipment in stand-by mode: Current 1.0000 mA full-scale, 0.1 μ A resolution
- Wide measurement range, up to 50.000 A direct input



SPECIFICATIONS	
Measurement lines	Single-phase/two-wire
Measurement items	Voltage, Current, Current peak, Active power, Apparent power, Reactive power, Power factor, Phase angle, Frequency, Power integration, Current integration
Measurement ranges	Voltage: 15.000V to 600.00V, auto or 6 ranges Current: 1.000mA to 50.000A, auto or 15 ranges Power: 15.000mW to 30.000kW, auto or 90 ranges Frequency: 4Hz to 100kHz, auto or 2 ranges
Integration range	0 to ± 999999 MAh/ MWh, (integration time up to 10000 hours)
Wave peak measurement	Current (displays maximum absolute value)
Basic accuracy	$\pm 0.1\%$ rdg. $\pm 0.1\%$ f.s. (active power, at 45 to 66Hz)
Frequency characteristics	1Hz to 100kHz (1Hz to 100kHz at 10A or less, 10Hz to 10kHz at 20A to 30A, 50/60Hz at 30A to 50A)
Signal output	Analog level: Voltage, current, active power, 5V DC f.s. Waveform monitor: Voltage, current, 1V rms f.s.
Other function	Comparator function for 2 items Scaling function (PT /CT/SC), Displays a moving average function, GP-IB/RS-232C interface
Sampling rate	5 times /second
Power supply	100 to 240 V AC, 50/60 Hz
Dimensions, mass	210W \times 100H \times 261D mm, 2.5 kg
Accessories	Power cord (1), Connector for EXT I/O (1)

OPTIONS	
GP-IB CONNECTOR CABLE (2 m)	9151-02
GP-IB CONNECTOR CABLE (4 m)	9151-04
PRINTER	9442
AC ADAPTER (for the 9442, EU), 9443-03 (USA)	9443-02
CONNECTION CABLE (for the 9442)	9444
RECORDING PAPER	1196
(25 m, 10 rolls /1 set, for the 9442)	

POWER HiTESTER 3333 3333-01

Your Solution to Meeting Energy Saving Requirements

- Guaranteed for 3 years
- High Accuracy ($\pm 0.1\%$ rdg. $\pm 0.1\%$ f.s.)
- Maximum Cost Performance

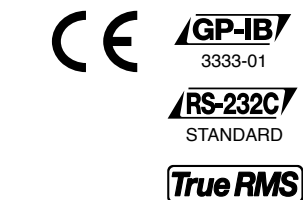

SPECIFICATIONS	
Measurement lines	Single-phase/two-wire
Measurement items	Voltage, Current, Active power, Apparent power, Power factor
Measurement ranges	Voltage: 200.0 V (300.0 Vmax), Current: 50.00 mA to 20.000 A (30.00 Amax), 6 ranges Power: 10.000 W to 4.000 kW, 6 ranges
Basic accuracy	$\pm 0.1\%$ rdg. $\pm 0.1\%$ f.s. (active power, at 45 to 66 Hz)
Frequency characteristics	45 Hz to 5 kHz
Other functions	Scaling function (PT/CT), Displays a simple average function, RS-232C interface (Model 3333-01 also includes GP-IB interface)
Sampling rate	5 times/second
Power supply	100 to 240 V AC, 50/60 Hz, 20 VA max
Dimensions, mass	160W \times 100H \times 227D mm, 1.9 kg
Accessories	Power cord (1)

OPTIONS			
PRINTER	9442	RS-232C CABLE (9-pin to 9-pin, crossed cable/1.8m)	9637
CONNECTION CABLE (for 9442)	9444	RS-232C CABLE (9-pin to 25-pin, crossed cable/1.8m)	9638
RECORDING PAPER	1196	GP-IB CONNECTOR CABLE (2m)	9151-02
AC ADAPTER (for 9442, EU)	9443-02	GP-IB CONNECTOR CABLE (4m)	9151-04
AC ADAPTER (USA)	9443-03		

POWER HiTESTER 3334 3334-01

Solves All of your Energy Consumption Testing Needs

- DC measurement mode, AC, and AC+DC measurement possible
- Integration function for current and power
- High basic accuracy $\pm 0.2\%$
- Extended Period of Guaranteed Accuracy of 3 Years



SPECIFICATIONS	
Measurement lines	Single-phase/ two-wires
Measurement items	Voltage, Current, Active power, Apparent power, Power factor, Frequency, Integration (current, active power), Waveform peak (voltage and current)
Measurement ranges	[Voltage] AC/DC 15.000/30.00/150.00/300.0V [Current] AC/DC 100.00/300.0 mA, 1.0000/3.000/10.000/30.00A [Power] 1.5000 W-9.000 kW (combination of voltage and current ranges)
Integration measurement	[Current] No. of displayed digits: 6 digits (from 0.00000mAh, Polarity-independent integration and Sum value)
Integration time up to 10,000 hours	[Active power] No. of displayed digits: 6 digits (from 0.00000mWh, Polarity-independent integration and Sum value)
Basic accuracy	$\pm 0.1\%$ rdg. $\pm 0.2\%$ f.s. (DC), $\pm 0.1\%$ rdg. $\pm 0.1\%$ f.s. (45Hz to 66Hz) Note: Provided accuracy of 1 Year, typical value
Display refresh rate	5 times per second
Frequency characteristics	DC, 45Hz to 5kHz
Waveform output	Parameter output representation: voltage, current and active power (3 simultaneous channels), Output voltage: 1V DC f.s.
Analog output (D/A output)	Parameter output representation: voltage, current active power and selected 1 item (4 simultaneous channels), Selected 1 item from apparent power, power factor, current integration, active power integration, Output voltage: ± 2 V DC f.s.
Functions	Rectification method switchable between AC+DC (True RMS), DC (simple average), AC (True RMS), Wave peak measurement, VT or CT ratio settings, Average function
Power consumption	100V to 240V AC, 50/60Hz, 20VA max.
Dimensions and mass	210W \times 100H \times 245D mm, 2.5kg
Accessories	Power cord (1)







OPTIONS			
PRINTER	9442	RS-232C CABLE (9-pin to 9-pin, crossed cable/1.8m)	9637
CONNECTION CABLE (for 9442)	9444	RS-232C CABLE (9-pin to 25-pin, crossed cable/1.8m)	9638
RECORDING PAPER	1196	GP-IB CONNECTOR CABLE (2m)	9151-02
AC ADAPTER (for 9442, EU)	9443-02	GP-IB CONNECTOR CABLE (4m)	9151-04
AC ADAPTER (USA)	9443-03		

Electronic Measuring Instruments







Electronic Measuring Instruments Index

For low resistance measurement Battery Testers

 3540 , -01, -02, -03 Testing source DC 100 ms response 16 times/sec. sampling Comparator (buzzer only) p.28	 3541 Wide measurement range 0.1 $\mu\Omega$ (20m Ω range) to 110M Ω High speed and High precision p.28	 3560 Testing source AC 1kHz 50/60 times/sec. sampling Comparator output, full remote control, RS-232C included GP-IB or Printer interface option p.29	 3561 The perfect battery tester for the production line Testing source AC 1kHz EXT I/O, RS-232C, GP-IB p.29	 3554 For medium to high- capacity lead-acid storage battery: UPS and similar applications Check battery deterioration p.59	 3555 For compact storage batteries: portable telephones and similar applications Check battery deterioration p.59
--	---	---	--	---	---

Inductance, Capacitance, or Impedance Meters

 3511-50 7 measurement items Testing source frequency 120Hz, 1kHz Comparator output, RS-232C included, GP-IB option p.30	 3522-50 14 measurement items Testing source frequency DC, 1mHz to 100kHz Comparator output, GP-IB or RS-232C option p.31	 3532-50 14 measurement items Testing source frequency 42Hz to 5MHz Comparator output, GP-IB or RS-232C option p.31	 3535 14 measurement items Testing source frequency 100kHz to 120MHz Comparator output GP-IB and RS-232C p.30	 3504/3504-10 3505/3506 C, D Testing Testing source frequency 120Hz, 1kHz, 100kHz, 1MHz Comparator output, RS-232C included, GP-IB (3504) p.30	 3501 C Testing Testing source signal 4V DC/ one time Indicator type
--	---	---	---	---	--

Signal Sources, Waveform Generators

 7011 DC signal source Voltage, Current, Thermoelectric power Measurement function p.37	 7016 DC signal source Voltage, Current, Measurement function p.37	 7075 (4ch) 7075-01 (2ch) Arbitrary waveform generator Function generator, Sweep sequence function p.37
---	--	--

DMMs

 3237/3238/3239 High speed DMM 199999 count display p.32
--

Digital ultra-insulation / micro ammeter

 DSM-8104 (1ch) DSM-8542 (4ch) PSU-8541 (power source unit) Measurement voltage : DC 0.1 - 1,000 V Measurement range : 1 $\times 10^7$ - 3 $\times 10^{16}$ Ω p.33

Super megohm meter

 SM-8213/8215 /8216/8220 Measurement voltage : 5 - 1,000 V DC Meas. range :0.05 - 2 \times 10 ¹⁶ M Ω (SM-8220) p.33

Safety Standards Measuring Instruments

Insulation Test Equipment  3154 Testing voltage 25 /50 /100 /250 /500 /1000 V Comparator output Timer function p.35	Leakage current of Medical Equipment  3156 Leakage current for use in testing electric and medical appliances RS-232C p.36	Protective ground Test Equipment  3157-01 Testing source AC Protective ground tester indispensable for standard certification p.36	Portable Withstanding Voltage HiTESTER  3173 Basic AC withstand voltage tester 3kV/30VA Economical and easy to operate p.36	Insulation/Withstanding Test Equipment  3159/3158/3153 Insulation and withstanding voltage tester 3158 : Withstanding voltage Test only p.34	AC AUTOMATIC INSULATION / WITHSTANDING HiTESTER  3174/3174-01 Full remote operation Built-in contact check function 100VA capacity for withstanding voltage testing p.35
---	--	--	---	---	--

RESISTANCE HiTESTER

3541

Measure from very low ($\mu\Omega$) to very high (M Ω) resistances with a single instrument

- **Wide Measurement Range**
0.1 $\mu\Omega$ (20 m Ω range) to 110.000 M Ω
- **High Speed & High Precision Measurements**
As fast as 0.6 ms with 70 ppm precision (in the 2 k Ω to 110 k Ω range)
- **Two Types of Temperature Correction**
Correction by Pt sensor or Infrared Thermometer
- **Equipped with EXT I/O, GP-IB and RS-232C interfaces**
Easily integrates into automated production lines



CE **GP-IB** STANDARD **RS-232C** STANDARD

SPECIFICATIONS

Measurement	Four-terminal resistance measurement 0.1 $\mu\Omega$ (20 m Ω range) to 110.000 M Ω Low power four-terminal resistance measurement 10 $\mu\Omega$ (2 Ω range) to 2.00000 k Ω Temperature measurement (Pt) -10.0 to 99.9 $^{\circ}$ C Temperature measurement (analog input) 0 to 2V
Accuracy	70ppm of rdg+15ppm of f.s. (2k Ω .20k Ω range slow Ω)
Functions	Temperature correction, temperature conversion, self calibration, measurement fault detection, overflow detection, offset voltage compensation, average, statistical calculation, key lock, save/load, comparator, BIN measurement
Interface	GP-IB, RS-232C, EXT-I/O
Power supply	100 to 240 VAC 50/60 Hz
Dimensions	Approx. 215W \times 80H \times 295D mm (excluding projections)
Mass	Approx. 2.6 kg
Accessories	CLIP TYPE LEAD 9287-10, TEMPERATURE PROBE 9451, Power Cord, EXT I/O Male Connector

OPTIONS

CLIP TYPE LEAD	9452
FOUR TERMINAL LEAD	9453
ZERO ADJUSTMENT BOARD	9454
PIN TYPE LEAD (for ultra precision)	9455
PIN TYPE LEAD	9461
PIN TYPE LEAD	9465
PIN TYPE LEAD	9465-10
PIN TYPE LEAD	9770
PIN TYPE LEAD	9771
LARGE CLIP TYPE LEAD	9467
CONNECTION CABLE (for multipolar connectors)	9300
RS-232C CABLE (9pin-9pin/cross/1.8m)	9637
RS-232C CABLE (9pin-25pin/cross/1.8m)	9638
GP-IB CONNECTOR CABLE (2m)	9151-02
GP-IB CONNECTOR CABLE (4m)	9151-04
PRINTER	9670
AC ADAPTER (for 9670)	9671
BATTERY PACK (for 9670)	9672
BATTERY CHARGER (for 9672, 100V only)	9673
RECORDING PAPER (80mm \times 25m, 4 rolls)	9237



m Ω HiTESTER

3540 | 3540-01 | 3540-02 | 3540-03

Offers selectable manual measurement or system application

- 4-terminal method milli-ohmmeter (Fast 100-ms Response)
- Comparator function memorizes up to seven tables
- Temperature compensation function measures temperature and calculates value relative to copper at 20 $^{\circ}$ C



CE **RS-232C** Model 3540-03

SPECIFICATIONS

Measurement ranges and Accuracy	30 m Ω to 30 k Ω , 7 ranges, 3500 full digits ± 0.1 % rdg. ± 6 dgt. (30 m Ω , 3 Ω range) ± 0.1 % rdg. ± 4 dgt. (300 m Ω , 30 Ω to 30 k Ω range)
Measurement current	100 mA (30 m Ω , 300 m Ω range) to 10 μ A (3 k Ω , 30 k Ω range)
Max. applied measurement voltage	3.5 mV DC (30 m Ω range) to 350 mV DC (30 k Ω range)
Sampling speed	16 times /second (fast mode), 4 times /second (slow mode)
Response time	100 ms (fast mode), 300 ms (slow mode)
Display	3500 full digits, Liquid Crystal Display
Measurement method	Four-terminal measurement
Open-circuit terminal voltage	4.0 V Max. (30 m Ω to 30 k Ω all ranges)
Digital input/output (-01, -02 and -03 Ver. only)	TTL output BCD, or other inputs /outputs for external control
Comparator functions	Setting: Upper and lower limit, or reference value and % for resistance. Up to 7 tables Output: 3 levels (Hi, In, Lo), Open-collector, LED display, beep sound
Interface	External printer (-02 only), RS-232C (-03 only)
Power supply	LR6 (AA) or R6P (AA) $\times 6$, or 9445-02, -03 AC ADAPTER (9V, 1A)
Dimensions, mass	215W \times 61H \times 213D mm, 900 g, 1 kg (-01, -02, -03)
Accessories	CLIP-TYPE LEAD 9287-10(1), TEMPERATURE PROBE 9451(1), Fuse(1), Ferrite Clamp(2), External Connector Socket (-01 only)

OPTIONS

DIGITAL PRINTER	9203
RECORDING PAPER (10 m, 10 rolls /1set)	9233
CONNECTION CORD (for 9203-3540-02, 2m)	9425
AC ADAPTER (100 to 240 VAC, 9 V/1A output, for USA)	9445-02
AC ADAPTER (100 to 240 VAC, 9 V/1A output, for EU)	9445-03
CLIP TYPE LEAD	9452
FOUR-TERMINAL LEAD	9453
PIN TYPE LEAD	*9455
PIN TYPE LEAD	9461
PIN TYPE LEAD	9465
PIN TYPE LEAD	9465-10
PIN TYPE LEAD	9770
PIN TYPE LEAD	9771
CLIP TYPE LEAD WITH TEMPERATURE SENSOR	9460
LARGE CLIP-TYPE LEAD	9467
RS-232C CABLE (9pin-9pin)	9637
RS-232C CABLE (9pin-25pin)	9638

*Note: The 9455 probe is a precision instrument. Exercise appropriate care when handling it.

The 3540 is the low-price version without external control interfaces, for manual measurement. The 3540-01 adds BCD output and external control, the 3540-02 includes a printer interface and the 3540-03 includes an RS-232C interface.

AC mΩ HiTESTER | 3560

For measurement requirements from contact resistance to internal resistance and voltage of batteries

- Contact Resistance measurement for switches
- Low-power resistance measurement
- Battery measurement
- High-resolution ($1\mu\Omega$ in the 30mΩ. range)



SPECIFICATIONS

Measurement ranges	30 mΩ to 3 kΩ, 6 ranges, $\pm 0.5\%$ rdg. ± 8 dgt. (all ranges)
Accuracy	In case of MEDIUM: Add 3 dgt. to the above dgt. error. FAST: $\pm 0.5\%$ rdg. ± 8 dgt. (30 mΩ), $\pm 0.5\%$ rdg. ± 6 dgt. (other ranges). However, in case of FAST, the display counter decreases 4 digits in all ranges.
Measurement current	7.4 mA (30 mΩ range) to 1.5μA (3 kΩ range)
Max. applied measurement voltage	60 V DC (AC input is not possible)
Sampling speed	50 times /s (FAST) to 1.56 times /s (SLOW) :at 50 Hz mode 60 times /s (FAST) to 1.88 times /s (SLOW) :at 60 Hz mode
Display	31000 full digits (resistance), 50000 full digits (voltage), Fluorescent tube.
Measurement method	1 kHz AC four-terminal measurement
Open-circuit terminal voltage	20mV peak max. (30 mΩ to 3 kΩ all ranges)
Comparator functions	Setting: Upper and lower limit. Up to 30 tables Output: 3 levels (Hi, In, Lo) or (Pass, Fail), Open-collector, Display, Beep sound
Interface	RS-232C (standard), GP-IB or External printer (option)
Power supply	100 to 240 V AC, 50/60 Hz
Dimensions, mass	215W×80H×320D mm, 2.1 kg
Accessories	CLIP-TYPE LEAD 9287-10 (1), Power cord(1)

OPTIONS

DIGITAL PRINTER	9203
RECORDING PAPER (10 m, 10 rolls /1set)	9233
CONNECTION CORD (for 9203-3560, 2m)	9425
CLIP-TYPE LEAD	9452
FOUR-TERMINAL LEAD	9453
ZERO ADJUSTMENT BOARD (when 9461 or 9465 is used)	9454
PIN TYPE LEAD	*1 9455
PIN TYPE LEAD	9461
PIN TYPE LEAD	9465
PIN TYPE LEAD	9465-10
PIN TYPE LEAD	9770
PIN TYPE LEAD	9771
LARGE CLIP-TYPE LEAD	9467
GP-IB INTERFACE	*2 9588
PRINTER INTERFACE	9589
GP-IB CONNECTION CABLE (2 m /4 m)	9151-02/04

*1Note: The 9455 probe is a precision instrument. Exercise appropriate care when handling it.

*2Note: Non-CE mark product

BATTERY HiTESTER | 3561 | 3561-01

Simultaneous high-speed testing of the internal resistance and voltage of small secondary batteries

- The perfect battery tester for the production line
- High speed and reliable battery inspection
- High precision accuracy
- Choice of PC interfaces for full remote operation



(Choose Model 3561-01)

SPECIFICATIONS

Measurement ranges and Accuracy	300 mΩ to 3Ω, 2 ranges, $\pm 0.5\%$ rdg. ± 5 dgt. 20 V, $\pm 0.01\%$ rdg. ± 3 dgt. (Input impedance 1MΩ)
Measurement current	10 mA (300 mΩ range) to 1 mA (3Ω range)
Max. applied measurement voltage	± 22 V DC rated input voltage ± 70 V DC maximum rated voltage above ground
Sampling speed	Four steps 7 ms(Extra-FAST), 23 ms(FAST), 83/69 ms(Medium), 258/251 ms(Slow)
Display	31000 full digits (resistance), 199999 full digits (voltage), Fluorescent tube
Measurement method	1kHz AC four-terminal measurement
Comparator functions	Setting: Upper and lower limit Output: 3 levels (Hi, In, Lo) or (Pass, Fail), Open-collector, Display, Dual audible indicator
Panel save/load	Up to 126 configuration settings
Other functions	Over-range display, measurement error detection Self-calibration, dual comparators, key-lock
Interface	External I/O, RS-232C, Printer (RS-232C), GP-IB(Model 3561-01)
Power supply	100 to 240 V AC, 50/60 Hz
Dimensions, mass	215W×80H×295D mm, 2.4 kg
Accessories	Power cord(1)

OPTIONS

CLIP-TYPE LEAD	9287-10
CLIP-TYPE LEAD	9452
FOUR TERMINAL LEAD	9453
PIN TYPE LEAD (for ultra precision)	9455
PIN TYPE LEAD	9465-10
LARGE CLIP-TYPE LEAD	9467
PIN TYPE LEAD	9770
PIN TYPE LEAD	9771
RS-232C CABLE (9pin-9pin/cross/1.8m)	9637
RS-232C CABLE (9pin-25pin/cross/1.8m)	9638
GP-IB CONNECTOR CABLE (2m)	9151-02
GP-IB CONNECTOR CABLE (4m)	9151-04
PRINTER	9670
AC ADAPTER (for 9670)	9671
BATTERY PACK (for 9670)	9672
BATTERY CHARGER (for 9672, 100V only)	9673
RECORDING PAPER (80 mm × 25 m, 4 rolls)	9237

LCR HiTESTER 3535

High-speed LCR meter with up to 120MHz sampling

- Wide range from 100kHz to 120MHz
- High speed LCR testing (6ms/sample)
- Removable head amplifier
- "Load compensation function" for comparing standard component and providing compensation



SPECIFICATIONS

Measurement parameters	Z , Y , Q, Rp, Rs(ESR), G, X, B, θ, Ls, Lp, Cs, Cp, D(tanδ)		
	1kΩ range	10kΩ range	100kΩ range
Measurement Range: Reference Value	Z · R	100Ω to 2kΩ	1kΩ to 20kΩ
	C	0.066pF to 15.9μF	0.066pF to 1.59nF
	L	0.133nH to 3.18mH	1.33μH to 31.8mH
	θ	-180.00° to 180.00°	
Measurement Frequency	Range	100kHz to 120MHz	
	Resolution setting	4digits (when using front panel to make setting)	
	100.0kHz to 1.000MHz	100Hz steps	
	1.000MHz to 10.000MHz	1kHz steps	
	10.00MHz to 100.0MHz	10kHz steps	
	100.0MHz to 120.0MHz	100kHz steps	
Measurement Levels	When using GP-IB or RS-232C interfaces, resolution is 1Hz.		
	Accuracy	±0.005% max. against set value	
	Open Terminal Voltage (V) and Constant Voltage (CV) Modes	5mV to 1V, max. 20mA (up to 10.000MHz)	
	Resolution	1mV steps	
	Accuracy	±(5%+5mV)×(2+log f) (f in terms of MHz)	
	Constant Current (CC) Mode	200μA to 10mA, max. 0.5V (from 10.01 MHz)	
Basic accuracy	Z : ±0.5% rdg.; θ : ±0.3°		
	Output impedance 50Ω ±10Ω (at 100kHz)		
Power Supply	100V to 240V AC, 50/60Hz Approx. 50VA		
Dimensions, mass	Approx. 360W×130H×360D mm ; 8.3kg		

OPTIONS

(Model 3535 cannot be used alone. Measurement requires optional head amp unit and test fixture or Probe.)

HEAD AMP UNIT	9700-10	GP-IB CONNECTION CABLE (2m/4m)	9151-02/04
SMD TEST FIXTURE	*9677	PRINTER	9442
SMD TEST FIXTURE	9699	AC ADAPTER (for the 9442, EU), 9443-02	9443-03 (USA)
CONNECTION CABLE	9678	CONNECTION CABLE (for the 3535/9442)	9444
		RECORDING PAPER (25m, 10rolls/1set, for the 9442)	1196
		RS-232C CABLE (9pin-9pin/1.8m)	9637
		RS-232C CABLE (9pin-25pin/1.8m)	9638

*Note: Non-CE mark product

LCR HiTESTER 3511-50

Compact & powerful dedicated LCR measurement in 5m second timeframes

- High speed measurement : 5ms (1 kHz) or 13ms (120 Hz)
- High precision accuracy : ±0.08 %
- Built-in comparator



SPECIFICATIONS

Measurement parameters	Z , θ, C, L, D, Q, R
Measurement method	Source : open terminal voltage 50mV, 500mV, 1Vrms (AC) sense: voltage, AC
Source frequency	120 Hz or 1 kHz
Measurement ranges	Z , R : 10 mΩ to 200.00 MΩ (depending on condition) θ : -90.00 to +90.00°, C : 0.940 pF to 999.99 mF, L : 1.600 μH to 200.00 kH, D : 0.0001 to 1.9900, Q : 0.85 to 999.99
Basic accuracy	Z : ±0.08% rdg.; θ : ±0.05°
Measurement times	Fast : 5 msec. to Slow : 300 msec. (at 1 kHz) Fast : 13 msec. to Slow : 400 msec. (at 120 Hz)
Display	99999 full digits, LED
Comparator functions	Setting : Upper and lower limit, absolute value, Output : 3 levels (Hi, In, Lo), Open-collector, Isolated
External printer	9442 (use with the 9443-02 or -03/9444)
Power supply	100 to 240 V AC, 50/60Hz
Dimensions, mass	210W×100H×168D mm, 2.5 kg
Accessories	Power cord(1), Fuse(1)

OPTIONS

(The 3511-50 cannot be used alone. Measurement requires optional test fixture or probe.)

FOUR-TERMINAL PROBE (DC to 100 kHz)	9140
PINCHER PROBE (DC to 5 MHz)	9143
TEST FIXTURE (cable connection type, DC to 5 MHz)	9261
TEST FIXTURE (direct connection type, DC to 5 MHz)	9262
SMD TEST FIXTURE (direct connection type, DC to 5 MHz)	9263
DC BIAS VOLTAGE UNIT (± 40 V DC max.)	9268
DC BIAS CURRENT UNIT (± 2 A DC max.)	9269
CONNECTION CORD (for 9268/9269; BNC to BNC, 1.5 m)	9165
CONNECTION CORD (for 9268/9269; BNC to clip, 1.5 m)	9166
GP-IB CONNECTION CABLE (2 m / 4 m)	9151-02/04
GP-IB INTERFACE	9518-01
PRINTER	9442
AC ADAPTER (for the 9442, EU), 9443-02	9443-03 (USA)
CONNECTION CABLE (for the 3511-50/9442)	9444
RECORDING PAPER (25 m, 10 rolls/1 set, for the 9442)	1196

C HiTESTER 3504 | 3504-10 | 3505 | 3506



A capacitance measurement instrument for High-speed MLCC Inspection with Constant Voltage

SPECIFICATIONS

Measurement items	Cs, Cp, D (loss coefficient)
Measurement frequency	3504/3504-10 120Hz, 1 kHz
	3505 1 kHz, 100 kHz, 1 MHz
	3506 1 kHz, 1 MHz
	Accuracy: ±0.01% or less Signal level: V or 500 mV
Measurement range	C : 0.940 pF to 20.0000 mF (5-digit display), Accuracy : ± 0.1 % D : 0.0001 to 1.9900, Accuracy : ± 0.0016
Measurement time	Nominal 2 ms (1kHz, FAST) Measurement speed:FAST, NORMAL, SLOW
Other function	Comparator, Audible buzzer, Printer (option) Bin (3504 only) Phase-synchronous function
Interface	RS-232C and EXT I/O (standard) GP-IB
Power supply	AC 100 V, 120 V, 220 V, or 240 V ±10% (selectable), 50/60 Hz, 100 VA max.
Dimensions and mass	Approx. 260 H×100 W×220 D mm, 3.8 kg
Supplied accessories	Power cord (1), spare fuse (1)

LCR HiTESTER | 3522-50

Better functionality and performance at a low cost

- High speed measurement of 5 ms LCR meter
- Higher frequency range (DC or 1 mHz to 100 kHz)
- Fourteen parameters measured (High resolution and high accuracy)
- DC resistance measurement



GP-IB
OPTION

RS-232C
OPTION

SPECIFICATIONS

Measurement parameters	$ Z $, $ Y $, θ , R_p (DCR), R_s (ESR, DCR), G , X , B , C_p , C_s , L_p , L_s , D ($\tan\delta$), and Q
Measurement method	Source: constant current 10μ to 100 mA(AC/DC), or constant voltage 10 mV to 5 V (AC/DC) open terminal voltage
Source frequency	DC, or 1mHz to 100kHz
Measurement ranges	$ Z $, $ R $, X : 10.00 m Ω to 200.00 M Ω (depending on condition) θ : -180.00 to +180.00°, C : 0.3200 pF to 1.0000 F, L : 16.000 nH to 750.00 kH, D : 0.00001 to 9.99999, Q : 0.01 to 999.99, $ Y $, G , B : 5.0000 nS to 99.999 S
Basic accuracy	$ Z $: ± 0.08 % rdg., θ : $\pm 0.05^\circ$
Measurement times typical values for displaying Z	Fast: 5 msec. to Slow2: 828 msec.
Display	99999 full digits, LCD with backlight display
Comparator functions	Setting: Upper and lower limit, percentage, or absolute value, Output: 3 levels (Hi, In, Lo), Open-collector, Isolated
External printer	9442 (use with the 9443-02 or -03/9446/9593-01)
Power supply	100 to 240 V AC, 50/60Hz
Dimensions, mass	313W×125H×290D mm, 4.5 kg
Accessories	Power cord(1), Fuse(1)

OPTIONS

(The 3522-50 cannot be used alone. Measurement requires optional test fixture or probe.)

FOUR-TERMINAL PROBE (DC to 100 kHz)	9140
PINCHER PROBE (DC to 5 MHz)	9143
TEST FIXTURE (cable connection type, DC to 5 MHz)	9261
TEST FIXTURE (direct connection type, DC to 5 MHz)	9262
SMD TEST FIXTURE (direct connection type, DC to 5 MHz)	9263
DC BIAS VOLTAGE UNIT (± 40 V DC max.)	9268
DC BIAS VOLTAGE UNIT (± 4 V DC max. for HDMI)	9268-01
DC BIAS CURRENT UNIT (± 2 A DC max.)	9269
CONNECTION CORD (for 9268/9269; BNC to BNC, 1.5 m)	9165
CONNECTION CORD (for 9268/9269; BNC to clip, 1.5 m)	9166
GP-IB CONNECTION CABLE (2 m / 4 m)	9151-02/04
GP-IB INTERFACE	9518-01
RS-232C INTERFACE	9593-01
PRINTER	9442
AC ADAPTER (for the 9442, EU), 9443-03 (USA)	9443-02
CONNECTION CABLE (for the 3522-50 /9442)	9446
RECORDING PAPER (25 m, 10 rolls /1 set, for the 9442)	1196

LCR HiTESTER | 3532-50

Impedance meter with a wide test frequency range

- Higher frequency range (42 Hz to 5 MHz)
- High speed measurement of 5 ms LCR meter
- Interactive touch panel operation
- Wide setting range for measurement voltage and current



GP-IB
OPTION

RS-232C
OPTION

SPECIFICATIONS

Measurement parameters	$ Z $, $ Y $, θ , R_p , R_s (ESR), G , X , B , C_p , C_s , L_p , L_s , D ($\tan\delta$), and Q
Measurement method	Source: constant current 10μ to 100 mA (42 Hz to 1 MHz), 50μ to 20 mA (1 MHz to 5 MHz), or constant voltage 10 mV to 5 V (42 Hz to 1 MHz), 50 mV to 1 V (1 MHz to 5 MHz) open terminal voltage
Source frequency	42 Hz to 5 MHz
Measurement ranges	$ Z $, R , X : 10.00 m Ω to 200.00 M Ω (depending on condition) θ : -180.00 to +180.00°, C : 0.3200 pF to 370.00 mF, L : 16.000 nH to 750.00 kH, D : 0.00001 to 9.99999, Q : 0.01 to 999.99, Y , G , B : 5.0000 nS to 99.999 S
Basic accuracy	$ Z $: ± 0.08 % rdg., θ : $\pm 0.05^\circ$
Measurement times typical values for displaying Z	Fast: 5 msec. to Slow2: 140 msec.
Display	99999 full digits, LCD with backlight display
Comparator functions	Setting: Upper and lower limit, percentage, or absolute value, Output: 3 levels (Hi, In, Lo), Open-collector, Isolated
External printer	9442 (use with the 9443-02 or -03/9446/9593-01)
Power supply	100 to 240 V AC, 50/60Hz
Dimensions, mass	352W×124H×323D mm, 6.5kg
Accessories	Power cord(1), Fuse(1)

OPTIONS

(The 3532-50 cannot be used alone. Measurement requires optional test fixture or probe.)

FOUR-TERMINAL PROBE (DC to 100 kHz)	9140
PINCHER PROBE (DC to 5 MHz)	9143
TEST FIXTURE (cable connection type, DC to 5 MHz)	9261
TEST FIXTURE (direct connection type, DC to 5 MHz)	9262
Note: Measurement ranges are limited when using the 9140, 9143	
SMD TEST FIXTURE (direct connection type, DC to 5 MHz)	9263
DC BIAS VOLTAGE UNIT (± 40 V DC max.)	9268
DC BIAS VOLTAGE UNIT (± 4 V DC max. for HDMI)	9268-01
DC BIAS CURRENT UNIT (± 2 A DC max.)	9269
CONNECTION CORD (for 9268/9269; BNC to BNC, 1.5 m)	9165
CONNECTION CORD (for 9268/9269; BNC to clip, 1.5 m)	9166
GP-IB CONNECTION CABLE (2 m / 4 m)	9151-02/04
GP-IB INTERFACE	9518-01
RS-232C INTERFACE	9593-01
PRINTER	9442
AC ADAPTER (for the 9442, EU), 9443-03 (USA)	9443-02
CONNECTION CABLE (for the 3532-50 /9442)	9446
RECORDING PAPER (25 m, 10 rolls /1 set, for the 9442)	1196

DIGITAL HiTESTER | 3238 | 3239

**High-accuracy, multi-functional model (3238)
A new DMM with 4-terminal resistance measurement! (3239)**

- Samples at rates of up to 300 samples/sec. (3.3 ms/ sample)
- Comparator function provides high-speed pass/fail evaluation
- Equipped with external input and output for sequence control
- Useful Save/Load function helps work go faster
- Interface supports full remote operation
- AC/DC current and frequency functions



SPECIFICATIONS	
DC voltage (DC V)	200m/2/20/200/1000V(±0.01% rdg. ±2dgt./2V)
AC voltage (AC V)	2/20/200/750V(±0.1% rdg. ±100dgt./45 to 10kHz) True RMS
DC current (DC A)	200m/2A(±0.1% rdg. ±6dgt./200mA)
AC current (AC A)	200m/2A(±0.3% rdg. ±100dgt./200mA, 45 to 3kHz) True RMS
Frequency	100/1k/10k/100k/300kHz (±0.015% rdg. ±2dgt./10 to 300kHz)
Resistance (Ω)	200/2k/20k/200k/2000k/20M/100MΩ (±0.02% rdg. ±2dgt./2k to 200kΩ)
Resistance (LPΩ)	2k/20k/200k/2000kΩ (±0.02% rdg. ±6dgt./2k to 200kΩ)
Open terminal voltage	6V DC max.(Ω, Diode check) 0.45V DC max.(LPΩ, Continuity check)
Continuity check	A built-in buzzer sounds when the resistance value is less than 50.00Ω.
Sampling rate	FAST approx. 300 samples/s , MEDIUM approx. 8 to 9 samples/s , SLOW approx. 1 sample/s
Display	LED max. 199999 (999999 for frequency)
Ancillary functions	Comparator, Average, Zero Adjust, Trigger and the Save/Load functions
Interface	External input/output,RS-232C, GP-IB(3238-01, 3239-01)
Power supply	AC 100V/120V/220V/240 V, (50/60Hz)
Dimensions and mass	approx. 215W×80H×265D mm, 2.6 kg
Accessories	TEST LEAD 9170(1)

OPTIONS	
CLAMP ON PROBE (10/20/50/100/200/500 A AC)	9010
CLAMP ON PROBE (10/20/50/100/200/500 A AC)	9018
CLAMP ON PROBE (20/50/100/200/500/1000 A AC)	9132
RS-232C CABLE (9pin-9pin, Reverse type/1.8m)	9637
RS-232C CABLE (9pin-25pin, Reverse type/1.8m)	9638
GP-IB CONNECTION CABLE (2 m /4 m)	9151-02/04
PRINTER	9442
AC ADAPTER (for the 9442, EU), 9443-03 (USA)	9443-02
CONNECTION CABLE (for 9442 printer)	9444
RECORDING PAPER (25 m, 10 rolls/1 set, for the 9442)	1196
FOUR TERMINAL LEAD for 3229 (refer to P.64)	

DIGITAL HiTESTER | 3237

**High-speed DMM (3.3ms/sample)
Minimizing tact time with sequence control at a truly affordable price**

- Samples at rates of up to 300 samples/sec. (3.3ms/ sample)
- Comparator function provides high-speed pass/fail evaluation
- Equipped with external input and output for sequence control
- Useful Save/Load function helps work go faster
- Interface supports full remote operation

SPECIFICATIONS	
DC voltage (DC V)	200m/2/20/200/1000V(±0.025% rdg. ±2dgt./2V)
AC voltage (AC V)	2/20/200/750V(±0.2% rdg. ±100dgt./45 to 3kHz) True RMS
Resistance (Ω)	200/2k/20k/200k/2000k/20M/100MΩ (±0.05% rdg. ±2dgt./2k to 2MΩ)
Resistance (LPΩ)	2k/20k/200k/2000kΩ (±0.05% rdg. ±6dgt./2k to 200kΩ)
Open terminal voltage	6V DC max.(Ω, Diode check) 0.45V DC max.(LPΩ, Continuity check)
Continuity check	A built-in buzzer sounds when the resistance value is less than 50.00Ω.
Sampling rate	FAST approx. 300 samples/s , MEDIUM approx. 8 to 9 samples/s , SLOW approx. 1 sample/s
Display	LED max. 199999
Ancillary functions	Comparator, Average, Zero Adjust, Trigger and the Save/Load functions
Interface	External input/output,RS-232C, GP-IB(3237-01)
Power supply	AC 100V/120V/220V/240 V, (50/60Hz)
Dimensions and mass	approx. 215W×80H×265D mm, 2.6 kg
Accessories	TEST LEAD 9170(1)

OPTIONS	
CLAMP ON PROBE (10/20/50/100/200/500 A AC)	9010
CLAMP ON PROBE (10/20/50/100/200/500 A AC)	9018
CLAMP ON PROBE (20/50/100/200/500/1000 A AC)	9132
RS-232C CABLE (9pin-9pin, Reverse type/1.8m)	9637
RS-232C CABLE (9pin-25pin, Reverse type/1.8m)	9638
GP-IB CONNECTION CABLE (2 m /4 m)	9151-02/04
PRINTER	9442
AC ADAPTER (for the 9442, EU), 9443-03 (USA)	9443-02
CONNECTION CABLE (for 9442 printer)	9444
RECORDING PAPER (25 m, 10 rolls/1 set, for the 9442)	1196



CAT II 300V
CAT I 500V



3237-01



STANDARD



DIGITAL ULTRA-INSULATION / MICRO AMMETER 1-CH | DSM-8104

- Measurement voltage : DC 0.1 to 1,000 V
Measurement range : 1×10^7 to $3 \times 10^{16} \Omega$
- Measures insulation resistance of capacity with high speed & high accuracy
- High resolution current measurements of 0.1 fA

SPECIFICATIONS

Measurement range	
DC Measurement Capability	
Current Measurement	
Measurement Range Name (Accuracy)	10pA $\pm (3.0\% \text{ of rdg} + 1.2\% \text{ of range})$
	100pA $\pm (1.5\% \text{ of rdg} + 0.6\% \text{ of range})$
	1nA $\pm (0.6\% \text{ of rdg} + 0.6\% \text{ of range})$
	10nA $\pm (0.4\% \text{ of rdg} + 0.5\% \text{ of range})$
	100nA $\pm (0.4\% \text{ of rdg} + 0.5\% \text{ of range})$
	1 μ A $\pm (0.4\% \text{ of rdg} + 0.5\% \text{ of range})$
	10 μ A $\pm (0.4\% \text{ of rdg} + 0.5\% \text{ of range})$
100 μ A $\pm (0.4\% \text{ of rdg} + 0.5\% \text{ of range})$	
Resistance Measurement	
Range of Measurement (Fundamental Accuracy)	$1 \times 10^{14} \sim 3 \times 10^{16}$ (Open-circuit) $\pm 4.0\% \text{ of rdg.}$
	$1 \times 10^{13} \sim 1 \times 10^{14}$ $\pm 4.0\% \text{ of rdg.}$
	$1 \times 10^{12} \sim 1 \times 10^{13}$ $\pm 2.0\% \text{ of rdg.}$
	$1 \times 10^{11} \sim 1 \times 10^{12}$ $\pm 0.8\% \text{ of rdg.}$
	$1 \times 10^{10} \sim 1 \times 10^{11}$ $\pm 0.6\% \text{ of rdg.}$
	$1 \times 10^9 \sim 1 \times 10^{10}$ $\pm 0.6\% \text{ of rdg.}$
	$1 \times 10^8 \sim 1 \times 10^9$ $\pm 0.6\% \text{ of rdg.}$
$1 \times 10^7 \sim 1 \times 10^8$ $\pm 0.6\% \text{ of rdg.}$	
Measurement Time Setting	
Delay	0~9,999ms
Sampling Time	2~300ms
Voltage Generator	
Setting Voltage Accuracy and Resolution	
Setting Voltage Range	0.1 to 250.0V $\pm (0.1\% \text{ of setting} + 150\text{mV})$
Accuracy	251 to 1,000V $\pm (0.1\% \text{ of setting} + 400\text{mV})$

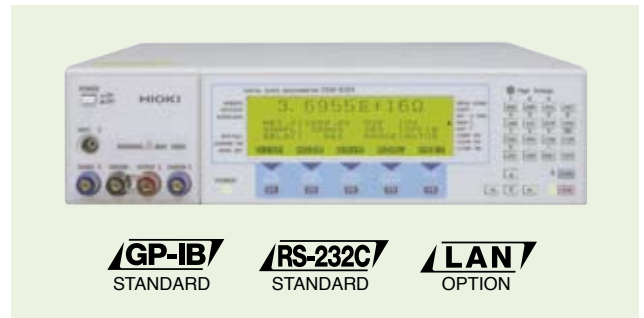

Current Limiter	
Setting Voltage Range	Current Limit Value
0.1 to 250.0V	5/10/50mA
251 to 1,000V	5/10mA
Measurement Check Function	
Voltage Monitor, Contact Check Function,	
Measurement Function	Comparator Measurement, Deviation/Percentage Measurement, Surface/Volume Resistivity Measurement
Interface, EXT-I/O	GP-IB, RS-232C, LAN (Option), Handler Interface
Power Supply	100V AC (115V, 220V, 240V factory option), $\pm 10\%$ at 50/60Hz Approx. 55VA
Dimension, mass	Approx. 332W \times 89H \times 450D mm Approx. 6.7kg
Accessories	Power cord (1) (Measurement leads are optional.)

OPTIONS

Measurement lead	0GE00002	1m, red
	0GE00001	1m, black
Interlock Connection Cable	DSM8104F	1m
Rack Mount Adapter	DSM8104E	
LAN Interface	DSM8104D	
Electrodes : refer to P.65		

DIGITAL ULTRA-INSULATION / MICRO AMMETER 4-CH | DSM-8542

POWER SOURCE UNIT | PSU-8541

- 4-channel, high-speed measurement capability when combined with PSU-8541 dedicated power source unit sold separately
- System compatibility made easy by connecting charge terminal handler interface
- Measures insulation resistance of capacity with high speed & high accuracy



SPECIFICATIONS DSM-8542	
Measurement Specification	4-ch same as DSM-8104 Specifications (with PSU-8541 dedicated power source unit sold separately)
SPECIFICATIONS PSU-8541	
Configuration	Voltage generator A (HIGH) 1 circuit 250V-150W, 1000V-120W Voltage generator B (LO) 1 circuit 10V-6W Current control Circuits (Measurement System) 4 circuits Current control Circuits (Charge System) 20 circuits
Voltage Generator (HIGH)	0.1V to 250.0V ($\pm 0.1\% \text{ of setting} + 150 \text{ mV}$) Max.600mA 251V to 1,000V ($\pm 0.1\% \text{ of setting} + 400 \text{ mV}$) Max.120mA
Voltage Generator (LO)	0.1V to 10.0V ($\pm 0.1\% \text{ of setting} + 150 \text{ mV}$) Max.600mA
Current limiter	0.1V to 250.0V (5/10/25/50mA) 251V to 1,000V (5mA)
Control	Control by the DSM-8542
Power Supply	100V AC $\pm 10\%$ at 50/60Hz Max. Approx. 350VA
Dimension, mass	Approx. 332W \times 178H \times 450D mm Approx. 28kg
Accessories	Power cord (1), DSM-8542 Connection Cable (2)

OPTIONS

RACK MOUNT ADAPTER	LMA-PSU
Electrodes : refer to P.65	

SUPER MEGOHM METER SM-8200 SERIES

- Meas. voltages : 5 – 1000V DC
- Digital/analog display on LCD (except SM-8216)
- Equipped with timer, remote starter, comparator & interlock function
- Compatible for measurement of several sample types of electrode & other devices



SPECIFICATIONS					
Measuring voltage & Measuring range	5V	SM-8213	SM-8215	SM-8220	SM-8216
	10V	2.5×10^8 to $1 \times 10^{10} \Omega$			
	15V	5×10^8 to $2 \times 10^{10} \Omega$		5×10^8 to $2 \times 10^{10} \Omega$	5×10^8 to $2 \times 10^{10} \Omega$
	25V	7.5×10^8 to $3 \times 10^{10} \Omega$			
	50V	1.25×10^9 to $5 \times 10^{10} \Omega$		1.25×10^9 to $5 \times 10^{10} \Omega$	1.25×10^9 to $5 \times 10^{10} \Omega$
	100V	2.5×10^9 to $1 \times 10^{11} \Omega$	2.5×10^9 to $1 \times 10^{11} \Omega$	2.5×10^9 to $1 \times 10^{11} \Omega$	2.5×10^9 to $1 \times 10^{11} \Omega$
	250V	5×10^9 to $2 \times 10^{11} \Omega$	5×10^9 to $2 \times 10^{11} \Omega$	5×10^9 to $2 \times 10^{11} \Omega$	5×10^9 to $1 \times 10^{12} \Omega$
	500V	1.25×10^{10} to $5 \times 10^{11} \Omega$	1.25×10^{10} to $5 \times 10^{11} \Omega$	1.25×10^{10} to $5 \times 10^{11} \Omega$	1.25×10^{10} to $5 \times 10^{11} \Omega$
1,000V	2.5×10^{10} to $1 \times 10^{12} \Omega$	2.5×10^{10} to $1 \times 10^{12} \Omega$	2.5×10^{10} to $1 \times 10^{12} \Omega$	2.5×10^{10} to $1 \times 10^{12} \Omega$	
Accuracy of measuring voltage	$\pm 3\%$ of setting voltage value				
Output current	Max. 50mA		Max. 2mA		
Measuring accuracy	$\pm 10\%$ (within 10 times range of min. value on each range at 20°C)				
Display	LCD (digital & analog display)				
Standard function	timer, comparator (alarm), remote start, HV-EN, RS-232C				
Power supply	100V, 120V, 220V, 240VAC $\pm 10\%$, but max. 250VAC, 50/60Hz (approx.25VA)				
Dimensions, mass	approx.284W \times 139H \times 215D mm (approx.4.3kgs)				
Accessories	0GE00002 1m, red 0GE00001 1m, black Power cord (1)				

OPTIONS

Electrodes : refer to P.65

AUTOMATIC INSULATION / WITHSTANDING HiTESTER 3153

Programmable testing, full remote control Automatic Insulation Withstanding Tester

- Insulation resistance test (DC50V~1200V), Withstanding voltage test (AC/DC5000V), full remote control in series
- Programmable testing
(Testing Programs 32 files, Testing points 50 steps/file)
- Accurate testing voltage generation by PWM control method
- HIGH VOLTAGE SCANNER 3930 (Option)



SPECIFICATIONS

■Withstanding test	
Testing voltage	AC 0.2 to 5.00 kV 500VA (maximum 30 minutes) DC 0.2 to 5.00 kV 50VA (continuous)
Voltage setting method	Digital setting
Waveform	Sin wave
Frequency	50/60Hz DC
Measurement range	Current: 0.01 to 100.0 mA, $\pm(2\%$ rdg. +5dgt.) 10mA/100mA(AC) AC (Average value rectified, RMS display)
■Insulation test	
Testing voltage	DC50 to 1200V
Measurement range	0.1 to 9999M Ω , 4 ranges
Judgment function	Contents: UPPER-FAIL / PASS / LOWER-FAIL (Digital setting window comparator method)
Timer section	Setting range: 0.3 to 999 seconds
Interfaces	EXT I/O, EXT SW, RS-232C, GP-IB
Display	Fluorescent tube display (digital), Analog meter
Monitor function	Output voltage, detection current, Insulation resistance
Power supply	AC100-120V/AC200-240V, (50/60 Hz), 1000VA max.
Dimensions, mass	320W×155H×480D mm, 18 kg
Accessories	H.V. TEST LEAD (high voltage side and return, 1 each) 9615, Power cord (1), spare fuse (1)

OPTIONS

REMOTE CONTROL BOX (single)	9613	RS-232C CABLE	9638
REMOTE CONTROL BOX (dual)	9614	(Dsub 9pin-25pin, cross, 1.8m)	
HIGH VOLTAGE SCANNER	3930	GP-IB CONNECTOR CABLE (2m)	9151-02
SAFETY TEST DATA MANAGEMENT SOFTWARE	9267	GP-IB CONNECTOR CABLE (4m)	9151-04
RS-232C CABLE	9637		
(Dsub 9pin-9pin, cross, 1.8m)			

INSULATION / WITHSTANDING HiTESTER 3159

Perform insulation resistance and withstand voltage testing in a single series

- Insulation resistance test (DC500V/1000V)
- Withstanding voltage test (AC5000V)
- Testing in series
(Insulation resistance test to Withstanding voltage test)
- Standard Interfaces (EXT I/O, EXT SW, RS-232C, STATUS OUT)



SPECIFICATIONS

■Withstanding test	
Testing voltage	0 to 2.5 kV / 0 to 5.0 kV AC, dual-range configuration (Average value rectified, effective value display) 500 VA (maximum 30 minutes)
Voltage setting method	Manual adjusted transformer
Waveform	Same as the power supply waveform
Frequency	Same as the power supply frequency
Measurement range	Current: 0.01 to 120 mA, $\pm(3\%$ f.s.+20 μ A) 2mA/8mA/32mA/120mA AC (Average value rectified, RMS display)
■Insulation test	
Testing voltage	DC500V/1000V
Measurement range	2M Ω to 2000M Ω (500V), 4M Ω to 2000M Ω (1000V)
Judgment function	Contents: UPPER-FAIL / PASS / LOWER-FAIL (Digital setting window comparator method)
Timer section	Setting range: 0.5 to 999 seconds
Interfaces	EXT I/O, EXT SW, RS-232C
Display	Fluorescent tube display (digital), Analog meter
Monitor function	Output voltage, detection current, Insulation resistance
Power supply	120 V AC, 50/60 Hz (3159-01) 220 V AC, 50/60 Hz (3159-02) 230 V AC, 50/60 Hz (3159-03) 240 V AC, 50/60 Hz (3159-04)
Dimensions, mass	320W×155H×330D mm, 18 kg-21.5kg
Accessories	H.V. TEST LEAD (high voltage side and return, 1 each) 9615, Power cord (1), spare fuse (1)

Options : refer to 3153 options

AC WITHSTANDING VOLTAGE HiTESTER 3158

Guarantees electrical and electronic equipment safety

- Measures between 0 to 5kV AC



SPECIFICATIONS

Withstanding test	
Test function	Withstanding test
Testing voltage	0 to 2.5kV / 0 to 5.0kV AC, dual-range configuration
Voltage testing method	Zero-toggle switch
Transformer capacity	500VA (maximum 30 minutes)
Voltage adjustment	Manually adjusted transformer
Waveform	Same as the power supply waveform
Frequency	Same as the power supply frequency
Measurement items	Voltage: 0 to 5kV AC (Average value rectified, RMS display) Current: 0.01 to 120mA AC (Average value rectified, RMS display)
Judgment function	Contents: UPPER-FAIL / PASS / LOWER-FAIL (Digital setting window comparator method)
Timer section	Setting range: 0.5 to 999 seconds
Interfaces	EXT I/O, EXT SW, RS-232C
Display	Fluorescent tube display (digital), Analog meter
Monitor function	Output voltage, detection current
Power supply	120V AC, 50/60Hz (3158-01) 220V AC, 50/60Hz (3158-03) 230V AC, 50/60Hz (3158-04)
Dimensions, mass	320W × 155H × 263D mm, 16kg (3158-01), 18kg (3158-03, -04)
Accessories	H.V. TEST LEAD (high voltage side and return, 1 each) 9615, Power cord (1), spare fuse (1)

Options : refer to 3153 options

AC AUTOMATIC INSULATION / WITHSTANDING HiTESTER | 3174 | 3174-01

- Built-in contact check function for both withstanding voltage and insulation resistance
- 100VA capacity for withstanding voltage testing
- Accurate test voltage generation by PWM method
- Full remote operation
- Store up to 8 settings in memory



GP-IB
3174-01

RS-232C
STANDARD

SPECIFICATIONS	
[Withstanding voltage test]	
Output voltage	0.2 to 5.0kV AC
Voltage setting method	Digital setting, 0.01kV resolution
Waveform, Frequency	Sine wave (5% or less distortion with no load), 50/60Hz selectable
Measurement range	0.01mA to 20.0mA, True RMS
Voltage meter	True RMS, ±1.5%rdg. (1000V or higher), ±15V (1000V or lower)
Judgment method	Window comparator method
[Insulation resistance test]	
Testing voltage	500, 1000V DC
No load voltage	1 to 1.2 times than the testing voltage
Rated testing current	1 to 1.2mA, Short circuit current: 4 to 5mA (500V) / 2 to 3mA (1000V)
Measurement range and accuracy	0.5MΩ to 999MΩ (500V), 1MΩ to 999MΩ (1000V): ±4%rdg. 1000MΩ to 2000MΩ: ±8%rdg.
Judgment method	Window comparator method

[Timer]	
Range and accuracy	0.3 to 999s (0.3 to 99.9s: ±50ms, 100 to 999s: ±0.5s)
Delay/Ramp timer	0.1 to 99.9s (±50ms)
Function	8 settings memory, Hold, Beeper, Contact check (withstanding voltage, insulation resistance)
Monitor function	Output voltage, Measured current, Insulation resistance
Power supply	100 to 240V AC (50/60Hz), 200VA max.
Dimensions, mass	320W × 155H × 395D mm, 15kg
Accessories	High Voltage Test Lead 9615 (1 each for HV and Return), Power cord (1)

OPTIONS			
REMOTE CONTROL BOX (single)	9613	RS-232C CABLE	9638
REMOTE CONTROL BOX (dual)	9614	(Dsub 9pin-25pin, cross, 1.8m)	
HIGH VOLTAGE SCANNER	3930	GP-IB CONNECTOR CABLE (2m)	9151-02
SAFETY TEST DATA MANAGEMENT SOFTWARE	9267	GP-IB CONNECTOR CABLE (4m)	9151-04
RS-232C CABLE	9637		
	(Dsub 9pin-9pin, cross, 1.8m)		

DIGITAL MΩ HiTESTER | 3154

For the laboratory to the production line, six test voltages from 25 to 1000V



RS-232C
STANDARD

SPECIFICATIONS	
Measurement function	Insulation resistance (Applied DC voltage method)
Testing voltage	25, 50, 100, 250, 500, 1000 V DC
Measurement range	25 to 50 V: 2MΩ to 200 MΩ, 3 ranges 100 to 250 V: 2MΩ to 2000 MΩ, 4 ranges 500 to 1000 V: 2MΩ to 4000 MΩ, 4 ranges
Accuracy	±2 % rdg. ±5 dgt. (at 25 to 100 V testing voltage, 0 to 20.00 MΩ) (at 250 V testing voltage, 0 to 100.0 MΩ) (at 500 to 1000 V testing voltage, 0 to 999 MΩ) ±5 % rdg. (at 25 to 50V testing voltage, 19.0 to 200.0MΩ) (at 100V testing voltage, 19.0 to 2000MΩ) (at 250V testing voltage, 100.1 to 2000MΩ) (at 500 to 1000V testing voltage, 1000 to 4000MΩ)
Response times	Fast: less than 0.7 second, Slow: less than 1.5 seconds (at manual ranging)
Sampling rates	Fast: 10 samples/s, Slow: 1 sample/s
Functions	Comparator functions: judgments PASS or FAIL Test time timer functions: 0.5 to 99 second Delay time timer functions: 0.1 to 99 second
Display	LED
Power supply	100 to 240 V AC (50/60 Hz)
Dimensions, mass	215W × 61H × 213D mm, 1.1 kg
Accessories	Power cord (1)

OPTIONS	
TEST LEAD	9185
TEST PROBE	9294
SWITCHED PROBE	9299
RS-232C CABLE (1.8 m) (9pin-9pin/Cross)	9637
RS-232C CABLE (1.8 m) (9pin-25pin/Cross)	9638
SAFETY TEST DATA MANAGEMENT SOFTWARE	9267

LEAK CURRENT HiTESTER | 3156

Leakage Current Measurement Essential for Electrical Safety

- Automatically compatible with Networks stipulated by IEC/UL/JIS standards
- Automatic measurement function (Measuring power supply polarity switching as well as the normal state / single failure state)
- Stores data for 100 units
- Power supply separation

SPECIFICATIONS

Measurement mode	Earth leakage current Leakage current between enclosure and earth / Leakage current between enclosure and line / Leakage current between enclosure and line / Patient leakage current I / Patient leakage current II / Patient leakage current III / Patient auxiliary current
Target current	DC / AC / AC+DC (25mA max), AC peak (75mA max)
Measurement range	DC / AC / AC+DC mode ; 50 μ A / 500 μ A / 5 mA / 25 mA AC peak mode ; 500 μ A / 1 mA / 10 mA / 75 mA
Measurement system	Indication of a current value calculated based the measured drop in voltage caused by simulated resistance of the human body. Measurement of true effective value. The measurement section ; chassis-grounded and floating.
Accuracy	DC / AC / AC+DC mode ; $\pm(2.0\%$ rdg. + 6 dgt.) AC peak mode ; $\pm(2.0\%$ rdg. + 2 dgt.) DC mode ; $\pm(2.0\%$ rdg. + 3 dgt.)
Input resistance	1 M Ω \pm 1 % (Excluding voltmeter section, simulated resistance of the human body)
Network (human simulated resistance)	For medical electrical equipment / For IEC 60990 / For JIS / For UL / General-purpose 1 / General-purpose 2



Functions	110 % voltage application function / Wiring check function / Automatic measurement function / Application line selection function / Ground fault prevention function / Setting of single-fault condition / Switching power supply polarity / Setting of measuring time / Measurement delay / Maximum value hold / Allowable value judgement / Data save / Clock / Data back up / etc.
Interface	EXT I/O , RS-232C , GP-IB
Power supply	100, 120, 220, 240 V AC (default setting) (50/60 Hz, Rated power ; 30VA)
Dimensions, mass	Approx. 320W \times 110H \times 263D mm, 4.0 kg
Accessories	TEST LEAD 9170-10(2), ENCLOSURE PROBE 9195(1), CARRYING CASE 9399(1), Alligator clip(3)(2 red, 1 black) AC Power cord(2), Spare fuse(2)

OPTIONS

RS-232C CABLE (1.8 m) (9pin-9pin/Cross)	9637
RS-232C CABLE (1.8 m) (9pin-25pin/Cross)	9638
SAFETY TEST DATA MANAGEMENT SOFTWARE	9267

AC GROUNDING HiTESTER | 3157-01

Protective ground tester indispensable for standard certification



SPECIFICATIONS

Measurement items	Low resistance, AC 4-terminal method
Generator section	Current generator principle: PWM constant current control, Current setting range: 3.0A to 31.0A (0.1A resolution), into 0.1 Ω load, Maximum output power: 130VA (at output terminals) Subject to derating according to ambient temperature (80% at 40°C) Frequency: 50Hz or 60Hz sine wave Soft start function: Apply current only after checking load connection
Monitor section	Resistance measurement: 0 to 1.800 Ω (0.001 Ω resolution), Accuracy: $\pm 2\%$ rdg. ± 4 dgt. (after zero-adjust), Current monitoring range: 0 to 35.0A AC (0.1A resolution), Monitoring cycle: 2 times/second
Other functions	Timer setting: Counts down time after start until preset time, or shows elapsed time after start. Setting range: 0.5 to 999 second, Comparator: Pass/Fail evaluation using preset upper/lower limit, I/O output, Memory function: max. 20 settings (with save/load)
Display	Fluorescent tube digital display
Power supply	100 to 120V, 200 to 240V AC (auto-switching), 50/60Hz
Dimensions, mass	320W \times 90H \times 263D mm, 7kg
Accessories	Power cord(1), Spare fuse(1), Shorting bar(2)

OPTIONS

RS-232C CABLE (1.8 m) (9pin-9pin/Cross)	9637
RS-232C CABLE (1.8 m) (9pin-25pin/Cross)	9638
SAFETY TEST DATA MANAGEMENT SOFTWARE	9267

PORTABLE WITHSTANDING VOLTAGE HiTESTER | 3173

An Economical and Simple way to Handle Withstand Voltage Testing

- Measures between 0 to 3kV AC
- External Control (Standard)



SPECIFICATIONS

Basic Specifications	
[Voltage generator]	
Output voltage range	0 to 3 kV AC (single range), 30 VA
Accuracy	$\pm 5\%$ f.s.
Waveform	Power waveform, Synchronized to power
[Current detector]	
Current cut-off	0.1 to 9.9 mA
Current cut-off accuracy	Setting value $\pm(5\%+0.05mA)$
Evaluation method	Analog comparator PASS, FAIL a buzzer sound and external I/O
[Timer area]	
Setting range	1 to 99 sec (1-second resolution)
Timer accuracy	Setting value $\pm(1\%+50msec)$
General Specifications	
EXT I/O signal	START and STOP, PASS and FAIL, TEST
Power supply	120 V AC (3173-01), 220 V AC (3173-02) 230 V AC (3173-03), 240 V AC (3173-04) 50/60 Hz 50 VA
Dimensions, Mass	Approx. 149 (W) \times 200 (H) \times 215 (D) mm Approx. 7.0 kg (for 120 to 240 V AC)
Accessories:	Power cord, spare fuse, H.V. TEST LEAD 9615 (1)

SIGNAL SOURCE | 7016

Signal Generator with DMM

- Constant voltage 0 to $\pm 1.5000V$ 0 to $\pm 15.000V$
- Constant current 0 to $\pm 25.000mA$
- Pulse generation and measurement



OPTIONS

COMMUNICATION PACKAGE(RS-232C)	3856-01
COMMUNICATION PACKAGE(USB)	3856-02
SHEATH TYPE TEMPERATURE PROBE	*9180
SURFACE TYPE TEMPERATURE PROBE	*9181
SHEATH TYPE TEMPERATURE PROBE	*9182
SHEATH TYPE TEMPERATURE PROBE(class1)	*9183
SHEATH TYPE TEMPERATURE PROBE(class1)	9472
SHEATH TYPE TEMPERATURE PROBE(class1)	9473
SHEATH TYPE TEMPERATURE PROBE(class1)	9474
SHEATH TYPE TEMPERATURE PROBE(class1)	9475
SURFACE TYPE TEMPERATURE PROBE	9476
TEST LEAD (Lead length:1m/standard accessories)	3851-10

*Non-CE mark products



SPECIFICATIONS

Generator functions and Accuracy	Constant voltage: 0 to $\pm 1.5V$, 100 μV resolution, 0 to $\pm 15V$, 1mV resolution, Sink/source: $\pm 25mA$, $\pm 0.03\%$ of setting ± 3 dgt. Constant current: 0 to $\pm 25mA$, 1 μA resolution, Sink/source: $\pm 12V$, $\pm 0.03\%$ of setting ± 5 dgt. Pulse signal generation: 0.5 to 4800Hz, 28 ranges, $\pm 0.005\%$ of setting ± 0.01 Hz
Measurement functions and Basic accuracy	DC Voltage: 50mV to 250V, 6 ranges, $\pm 0.03\%$ rdg. ± 5 dgt. AC Voltage: 50mV to 250V, 6 ranges, $\pm 0.7\%$ rdg. ± 20 dgt. AC+DC Voltage: 50mV to 250V, 6 ranges, $\pm 0.8\%$ rdg. ± 25 dgt. DC Current: 50 to 500mA, 2 ranges, $\pm 0.03\%$ rdg. ± 5 dgt. AC Current: -50 to 500mA, 2 ranges, $\pm 0.6\%$ rdg. ± 20 dgt. AC+DC Current: 50 to 500mA, 2 ranges, $\pm 0.7\%$ rdg. ± 40 dgt.
Measurement functions and Accuracy	Resistance: 500 Ω to 50M Ω , 6 ranges, $\pm 0.15\%$ rdg. ± 5 dgt. Diode & Continuity check: Possible Temperature: -40 to 1372 $^{\circ}C$, $\pm 0.3\%$ rgt. $\pm 3^{\circ}C$ (K type thermocouple, $^{\circ}F$ display possible) Frequency: 100Hz to 200kHz, 5 ranges, $\pm 0.02\%$ rdg. ± 3 dgt.
Display	LCD with backlight 51,000 counts
Power supply	LR6(AA) $\times 8$, included Ni-MH battery pack, or included AC adapter
Dimensions, mass	90W \times 192H \times 54D mm, 735g (instrument only)
Accessories	Carrying case(1), AC adapter(1), Battery(8), TEST LEAD 3851(1), Alligator clips(1), Yellow test lead(1), Test leads(1)

DC SIGNAL SOURCE | 7011

All-in-one Signal source

- Check thermocouple temperature sensors
- Generate various signals for electronic circuit and equipment testing
- Calibrate industrial equipment all with a single unit



OPTIONS

RJ SENSOR	9184
(for reference contact compensation)	
CARRYING CASE	9380
AC ADAPTER	9418-10

SPECIFICATIONS

Generator functions and Accuracy	Constant voltage: 0 to $\pm 2.5V$, 100 μV resolution, 0 to $\pm 25V$, 1 mV resolution, Sink /source: $\pm 25mA$, $\pm 0.03\%$ of setting ± 3 dgt. Constant current: 0 to $\pm 25mA$, 1 μA resolution, Sink /source: $\pm 25V$, $\pm 0.03\%$ of setting ± 3 dgt.
Thermoelectric power	TC ($0^{\circ}C$)/TC(RJ) K: -176.0 to 1372.0 $^{\circ}C$, E: -220.0 to 839.0 $^{\circ}C$, J: -208.0 to 1108.0 $^{\circ}C$, T: -169.0 to 400.0 $^{\circ}C$, R: -50 to 100 $^{\circ}C$, 101 to 1769 $^{\circ}C$, S: -50 to 100 $^{\circ}C$, 101 to 1769 $^{\circ}C$, B: 300 to 600 $^{\circ}C$, 601 to 1820 $^{\circ}C$
Basic Accuracy	$\pm 0.05\%$ of setting $\pm 0.5^{\circ}C$ (at Thermoelectric power K)
Measurement functions and Accuracy	Voltage: 0 to $\pm 2.5V$, 100 μV resolution, 0 to $\pm 25V$, 1 mV resolution, Input resistance: 1 M Ω , $\pm 0.03\%$ rdg. ± 2 dgt. Current: 0 to $\pm 25mA$, 1 μA resolution, Input resistance: 25 Ω , $\pm 0.03\%$ rdg. ± 2 dgt.
Temperature	-25.0 to 80.0 $^{\circ}C$, 0.1 $^{\circ}C$ resolution (using the 9184)
Standard resistance	100 Ω , $\pm 0.2\%$ rdg.
Power supply	LR6(AA) $\times 6$ or 9418-10 AC ADAPTER
Dimensions, mass	104W \times 180H \times 58D mm, 590 g (excluding batteries)
Accessories	INPUT CORD 9168(1), TEST LEAD 9170(1), Fuse(3)

WAVEFORM GENERATOR | 7075 7075-01

Arbitrary waveform generator with four independently controllable channels

- Even for complex signals, evaluation is made easy
- Easy touch panel operation
- Multiple channels, 4CH (7075), 2CH (7075-01)
- Large 128,000-Word/channel memory, sweep sequence functions



OPTIONS

- **Output cord**
CONNECTION CORD BNC to BNC, 1.5 m length 9165
CONNECTION CORD BNC to clip, 1.5 m length 9166

- **PC communication**
GP-IB CONNECTION CABLE 2 m length 9151-02
GP-IB CONNECTION CABLE 4 m length 9151-04

SPECIFICATIONS

Number of channels	7075: 4-channels, 7075-01: 2-channels
Output functions	Function generator, Arbitrary waveform generator (for each channel)
Max. output voltage	10 V range: 10 mV to 10 V o.c. (1 mV resolution) 1 V range: 1 mV to 1 V o.c. (0.1 mV resolution) 0.1 V range: 0.1 mV to 0.1 V o.c. (0.01 mV resolution) (o.c.: open-circuit)
Minimum load impedance	40 Ohm
Output impedance	50 Ohm $\pm 2\%$ (DC)
Function generator mode	Waveform types: sine, square (fixed 50 % duty), triangle, ramp-up, ramp-down, pulse, noise, DC. Frequency range: sine (10 mHz to 10 MHz), square (10 mHz to 10 MHz), triangle (10 mHz to 200 kHz), pulse (10 mHz to 200 kHz)
Arbitrary waveform generation mode	Voltage axis resolution: 16 bits (64000 counts) Waveform memory capacity: 128 kW/ch Filtering: 2-stage LPF, 50 Hz to 1 MHz, 14 steps. Waveform input methods: FD/GP-IB (direct download from MEMORY HiCORDER by FD or GP-IB), or RS-232C download (at use of 7990), Arbitrary waveform clock: Max. 4ch, Frequency range: 10 mHz to 10 MHz (10 mHz resolution)
Display	5.7-inch LCD (with touch panel)
Data storage	FDD $\times 1$, MS-DOS format
Power supply	100/120/200/230 V AC/auto selects, (50/60 Hz)
Dimensions, mass	345W \times 130H \times 286Dmm, 7075: 7.8 kg, 7075-01: 7.5 kg
Accessories	WAVEFORM CREATION SOFTWARE (CD-R $\times 1$) 7990

Environmental Measuring Instruments



Environmental Measuring Instruments Index

Temperature measurement



3441/3442 €€
-100 °C to 1300 °C
Choose from Basic or Waterproof models
..... p.41



3446-01, 3447-01 €€
-100°C to 1000°C 1 ch (3446)
-100°C to 300°C 2 ch (3447)
with built-in memory



3412-50 €€
-50 °C to 999 °C
With analog output

Rotation, Illumination



3403 Rotation €€
30 to 100,000 r/min
3404 Rotation €€
30 to 100,000 r/min,
Max. /Min. /Total /Period
..... p.58



3423 Illumination €€
20 to 200,000 lx, digital
..... p.41

Magnetic Field HiTESTER



3470 €€
Magnetic field tester for home appliances
..... p.60

Non-contact temperature measurement (via infrared radiation energy)



3415-01 €€
-50 °C to 500 °C
Two-beam laser marker
Narrow field measurement



3416-01 €€
-50 °C to 500 °C
LED spot marker
Spot measurement



3418 €€
-50 °C to 500 °C
Without laser marker
Narrow field measurement



3443 €€
-50.0 °C to 500.0 °C
Two-beam laser marker
Narrow field measurement
Data memory, Memory dump to printer, RS-232C interface
..... p.41



3444 €€
-50.0 °C to 500.0 °C
Two-beam laser marker
Narrow field measurement
MAX. MIN. indication, Analog output, RS-232C interface
..... p.41



3445 €€
-50.0 °C to 500.0 °C
Two-beam laser marker
Spot measurement
MAX. MIN. indication, Analog output, RS-232C interface
..... p.41

Data Loggers (Temperature/Humidity/Instrumentation/DC-Voltage/AC-Current/AC-Voltage/Leak-Current)



2300 Series
Remote Measurement System
Various measurement modules
Internal memory
LAN or SS Air Module
..... p.39



3641-20, 3632-20, 3633-20 €€
Temperature/Humidity
-40~85°C 0~100% rh
(using the 9680 sensor)
-40.0 °C to 180.0 °C
(external sensor)
..... p.40



3634-20 €€
Instrumentation
0 to 20.00 mA DC
..... p.40



3635-24, -25, -26 €€
DC Voltage
-24: ±500.0 mV DC
-25: ±5.000 V DC
-26: ±50.00 V DC
..... p.40



3636-20 €€
AC Current (2ch)
0 to 50.00/500.0 A AC
3637-20 €€
AC Voltage (1ch)
0 to 600.0 V AC
..... p.40



3638-20 €€
AC Leak Current
(2ch) with clamp-on leak sensor
..... p.40

Data Loggers (Pulse/Illumination/DC-Voltage/Communication Base) 2D Thermo Testing



3639-20 €€
Pulse Totalizer
9,999counts/interval
(1ch)
..... p.40



3640-20 €€
Illumination
2000/20000/200000 lx
(1ch)
..... p.40



3645-20 €€
Multi-range
Voltage Logger
with preheat
signal function
..... p.40



3911-20, 3912-20 €€
Communication Base
to analyze and process
on a personal computer
..... p.40



3460-50 €€
64-element thermopile
array sensor
Transfer data to PC via
RS-232C
..... p.41

REMOTE MEASUREMENT SYSTEM

2300 Series

Easily Construct a Centralized Data Management System for Monitoring Multiple Locations

LAN Module that paves the way for a low cost remote measuring system by utilizing existing data network

Smart Site

- Various measurement modules for temperature and humidity, instrumentation, and pulse
- Power measurement module for multiple circuits
- Large internal memory to prevent data loss due to communication problems
- Communication module with built-in real-time clock tracks the data of each measurement module to the second
- SS Air Module for constructing wireless systems



RS-232C 2343-20
LAN 2353-20

HUMIDITY MODULE 2301-20	Temperature 1ch and humidity 1ch. Use with optional sensor 9764 Temperature: -40.0 to 85.0°C Humidity: 0.0 to 100%RH
Pt MODULE 2302-20	Temperature 2ch (Pt100) 2 types of platinum resistance thermo sensors available
TC MODULE 2303-20	2ch temperature measurement using thermocouples (K, E, J, T). 4 TC types available
PULSE MODULE 2304-21	For 2ch pulse input (voltage, contact), maximum 16M pulses/interval Input pulse: 4kHz max. (voltage/electronic contact signal) 25Hz max. (mechanical contact signal)
INSTRUMENTATION MODULE 2305-20	Voltage / current 2ch measurement, for 4-20mA, 1-5V instrumentation signals
POWER METER MODULE 2331-20	For single circuit power measurement. Single-phase 2-wire to 3-phase 4-wire Voltage: AC 100/200V Current: AC 5A (with CLAMP ON SENSOR 9695-02), AC 50A (with 9695-02), AC 100A (with 9695-03 or 9661-01), AC 500A (with 9661-01)
POWER METER MODULE 2332-20	For multiple circuit power measurement: from 6 circuits of single-phase 2-wire to 3 circuits of 3-phase 3-wire installations Voltage: AC200V (100V accepted at 200V range) Current: AC 5A (with CLAMP ON SENSOR 9695-02), AC 50A (with 9695-02), AC 100A (with 9695-03 or 9661-01), AC 500A (with 9661-01) *3-phase 4-wire circuit cannot be measured
INPUT MODULE 2341-20	For recording the status of contact signals Input 8 ch, Input internal bus isolated Easily capture on/off status with LED
OUTPUT MODULE 2342-20	Acts as receiver of higher order external control device, outputs control signals and monitors data of measurement modules Output 8ch (Open corrector output), Output internal bus isolated

RS LINK MODULE 2343-20	For communicating with RS-232C interface equipped instruments Interface: RS-232C, Transfer speed: 57.6kbps(max.) Please inquire regarding compatible instruments. (Existing compatible HIOKI instruments include Models 3331 and 3332.)
AIR MODULE 2351	2.4GHz band SS radio system (RS-232C equipped) Transfer speed: 51.9kbps(fixed), RS-232C: 57.6kbps(max.) 2351-20 : For EU 2351-21 : For USA
WIRE MODULE 2352-20	For small-scale measurement systems or built-in use Interface: RS-232C, Transfer speed: 57.6kbps(max.)
LAN MODULE 2353-20	For data logging via LAN Interface: 10BASE-T
AC POWER MODULE 2361-20	Power supply for the communication modules and measurement modules (max. 10 modules) Input: AC 100 to 240V, Output: DC5V/2.4A
DC POWER MODULE 2362-20	Power supply for the communication modules and measurement modules (max. 10 modules) Input: DC 19 to 36V, Output: DC5V / 2.4A
MODULE BASE 2391	For connecting modules (3 slots reserved for power supply and communication module) 2391-01: For relay and master station, 2391-02: 5 measurement module slots, 2391-03: 10 measurement module slots *Model 2331 uses 2 slots
MODULE BASE 2392	For connecting MODULES (also connects with additional MODULE BASES for increased measurement capabilities) 2392-01: 1 slot; includes power and internal bus connection terminal 2392-02: 2 slots; connect with 2391-01 for additional measurement module slots * POWER MODULE not compatible; must use with Model 2392-01 to access POWER MODULE

Data Loggers | 3600 Series

Data Loggers for All Types of Measurements

For HACCP-related Temperature and Humidity Recording

HUMIDITY LOGGER	TEMPERATURE LOGGERS	
3641-20	3632-20	3633-20
		

Can alternately record temperature and humidity on two channels for temperature and humidity measurement
-40.0 °C to 85.0 °C
0.0 %rh to 100.0 %rh

Waterproof with built-in sensor for temperature measurement
-20.0 °C to 70.0 °C

External sensor for temperature measurement
-40.0 °C to 180.0 °C

For Recording Voltage

VOLTAGE LOGGERS		
3635-24, -25, -26	3645-20	3637-20
		

For measurement DC voltage
-24: ± 500.0 mV DC
-25: ± 5.000 V DC
-26: ± 50.00 V DC

With preheat function
For measuring DC voltage
Range: ± 50.00 mV to ± 50.00 V DC

For measuring AC voltage
Range: 600.0 V AC

For Recording Precipitation or Illumination

PULSE LOGGER	ILLUMINATION LOGGER
3639-20	3640-20
	

For cumulative pulse measurement for precipitation gauges, flow gauges, etc.

For illumination measurement
Range: 2,000 lux to 200,000 lux

For Recording Load Current and Monitoring Leak Current

INSTRUMENTATION LOGGER	CLAMP LOGGER	LEAK LOGGER
3634-20	3636-20	3638-20
		

For measuring typical instrumentation signals
Range: 20.00 mA DC

For measuring alternating current on two channels
Range: 50.00/500.0 A AC
(Clamp sensors sold separately)

For measuring alternating current on two channels
Range: 100.0/1000 mA AC
(Clamp sensors sold separately)

USB 1.1
3912-20: OPTION



RS-232C
3911-20: OPTION

CE



Accessories

				
HUMIDITY SENSOR 9680 Cord length: 1 m	CONNECTION CABLE 9632 Cord length: 1 m	CONNECTION CORD 9639 Cord length: 3 m	CONNECTION CABLE 9629 Cord length: 5 m	LUX SENSOR 9662 Cord length: 2 m



Options for 3634-20

	
CONNECTION CABLE 9633 Cord length: 1 m	CONNECTION CABLE 9634 Cord length: 1 m







Options for 3636-20

	
CLAMP ON SENSOR 9650 AC 100 A f.s./Up to φ 15 mm Cord length: 3 m	CLAMP ON SENSOR 9651 AC 500 A f.s./Up to φ 46 mm Cord length: 3 m

Options for 3638-20

	
CLAMP ON SENSOR 9657 AC 1.0 A f.s. / Up to φ 40 mm Cord length: 3 m	CLAMP ON SENSOR 9658 AC 1.0 A f.s. / Up to φ 12 × 30 mm Cord length: 3 m



Options for 3641-20 / 3633-20

					
HUMIDITY SENSOR (for 3641-20) 9680/9680-01/9680-02 -40.0 °C to 85.0 °C 0.0 %rh to 100.0 %rh Cord length: 9680: 1 m (provided), 9680-01: 5 m, 9680-02: 10 m	TEMPERATURE SENSOR (Molded plastic type) 9631-01/9631-11/9631-21 -40.0 °C to 180.0 °C Cord length: 9631-01: 1 m, 9631-11: 5 m, 9631-21: 10 m	TEMPERATURE SENSOR (Needle type) 9631-02 -40.0 °C to 120.0 °C Cord length: 1 m	TEMPERATURE SENSOR (Sheathed type) 9631-03 -40.0 °C to 120.0 °C Cord length: 1 m	TEMPERATURE SENSOR (Molded plastic type) 9631-05 -40.0 °C to 180.0 °C Cord length: 30 mm	TEMPERATURE SENSOR (Lug type) 9631-04/9631-14/9631-24 -30.0 °C to 180.0 °C Cord length: 9631-04: 1 m, 9631-14: 5 m, 9631-24: 10 m

COMMUNICATION BASE | 3911-20 | 3912-20



Analyze and Process Data on a Personal Computer

The 3911-20, 3912-20 COMMUNICATION BASE are used to transfer data to a personal computer.

		
3911-20	3912-20	
<p>Communication software included with the 3911-20, 3912-20 Compatible OS: Windows 95/98/NT4.0/Me/2000/XP/Vista</p>		

3911-20, 3912-20 : SPECIFICATIONS	
Recording Capacity	Max. 16,000 data points × 16 ch, 32,000 data points × 8 ch,
Communication method	RS-232C (3911-20 to a PC) USB 1.1 (3912-20 to a PC)
Power supply	4 × 1.5 V, LR03 (AAA) alkaline dry cell batteries
Dimensions and mass	3911-20: 69W×92H×36D mm, 150g (including batteries) 3912-20: 69W×128H×36D mm, 180g (including batteries)
Accessories	3911-20: LR03 (AAA) alkaline dry cell batteries (4), Communication software (1) 3912-20: USB cable (1), LR03 (AAA) alkaline dry cell batteries (4), Communication software (1)

Options for 3911-20

	
CABLE 9637 RS-232C 9-pin to 9-pin crossed cable/1.8 m	RS-232C CABLE 9638 9-pin to 25-pin crossed cable/1.8 m

Environmental Measuring Instruments

TEMPERATURE HiTESTER | 3441 | 3442

Supports temperature management demands of various applications



3441, 3442 : SPECIFICATIONS	
Material type	K type thermocouple (Chromel /Alumel)
Measurement range	-100°C to 1300°C (-148°F to 2372°F) The actual measurement range is restricted by the temperature probe.
Resolution	0.1°C*1 or 1°C*2
Unit Accuracy	±0.1%rdg. ±0.8°C (1.5°F)*1 or ±0.2% rdg. ±1°C (1.8°F)*2 (in addition to accuracy of temperature sensor) *1 during measurement from -100 to 199.9°C (-148°F to 392°F) *2 during measurement from 200 to 1300°C (392°F to 2372°F)
Display	LCD
Sampling rate	2 times/second
Contact compensation	Auto compensation
Functions	Max/Min temperature recording and display, display data hold, sensor discontinuity display, Over-range display, °C/°F display switching (3441-02, 3442-03), auto power save, low battery warning
Place of use	Indoor use to altitude of 2000 m
Power supply	R6P (AA)×4, or LR6 (AA)×4
Operating time	200 hours or better of continuous use (with manganese battery)
Dimensions, mass	74W×155H×24D mm, 160 g
Accessories	Strap band(1), R6P(AA) Batteries(4)

TEMPERATURE PROBE refer to P.66

TEMPERATURE HiTESTER | 3443 | 3444 | 3445

Non-contact measurement, quick and easy temperature management



3443 : SPECIFICATIONS	
Measurement range	-50.0°C to 500.0°C, 0.1°C resolution
Measurement field diameter	φ24mm at a distance of 1 m
Accuracy	±1 % rdg. (at 200.1 to 500.0 °C), ±2°C (at 0.0 to 200.0 °C), ±10 % rdg. ±2°C (at -50.0 to -0.1 °C)
Response time	1.6 seconds (95% response)
Date memory function	130 points of data, memory dump to printer
Analog output function	None
Interface	RS-232C output (requires 3909 INTERFACE PACK)
Other functions	Auto power save, low battery warning, auto-hold
Power supply	6F22(006P)×1, or AC adapter
Operating time	Continuous use of 20 hours (light on) and 50 hours (light off)
Dimensions, mass	47W × 200H × 48D mm, 280 g
Accessories	Carrying case(1), hand strap(1), 6F22(1), screwdriver(1)

3444, 3445 : SPECIFICATIONS	
Measurement range	-50.0°C to 500.0°C, 0.1°C, 0.1 or 1°C resolution switchable
Measurement field diameter	3444 : φ24mm at a distance of 1 m 3445 : φ2.5mm at a distance of 7 cm
Accuracy	±1 % rdg. (at 200.1 to 500.0 °C), ±2°C (at 0.0 to 200.0 °C), ±10 % rdg. ±2°C (at -50.0 to -0.1 °C)
Response time	1.6 sec (95% at 0.1°C resolution), 0.7 sec (95% at 1°C resolution)
Date memory function	None
Analog output function	Possible (requires 3909 INTERFACE PACK)
Interface	RS-232C output (requires 3909 INTERFACE PACK)
Other functions	Auto power save, low battery warning
Power supply	6F22(006P)×1, or AC adapter
Operating time	Continuous use of 20 hours (light on) and 50 hours (light off)
Dimensions, mass	47W × 200H × 48D mm, 280 g
Accessories	Carrying case(1), hand strap(1), 6F22(1), screwdriver(1)

OPTIONS : CONNECTING CABLE (2m) 9436

LUX HiTESTER | 3423

Digital illumination meter, maximum scale of 199,900 lx



3423: SPECIFICATIONS	
Measurement range	20 to 200,000 lx full-scale, 5 ranges
Accuracy	±4 % rdg. ±1 dgt. (environment temperature: 23 ±5°C)
Display	1999 full digits, LCD with EL backlight (Note : in the 20,000 lx range, the maximum is 19990 /10 digits steps, and in the 200,000 lx range, the maximum is 199900 /100 digits steps)
Response time	5 sec. or less (auto range), 2 sec. or less (manual range)
Receptor element	Silicon photodiode
Other functions	Sensor separate: Permits remote measurement with the sensor separated from the main unit.(using the 9436) Analog output: 200 mV DC at full scale rate
Power supply	R6P (AA) × 2 (Continuous use of 25 hours) or AC adapter (6 V, 300 mA)
Dimensions, mass	74W × 170H × 30D mm, 310 g (including the dry cells)
Accessories	9376 CARRYING CASE(1), Sensor cap(1), R6P(2)

2D THERMO HiTESTER | 3460-50



SPECIFICATIONS	
Detection element	Thermopile array
Measurement range	-50 to 1000°C
Sampling rate	Approx. 0.2 seconds
Number of elements	64 (Horizontal 8 × vertical 8)
Display element	Transmission type color TFT liquid crystal
Display Size	3.8 inch
Power supply	LR6 (AA) alkaline batteries × 6, AC adapter (3915 OPTION PACK)
Dimensions and Mass	Approx. 165W × 55H × 123D mm (main unit only with the LCD closed), Approx. 700 g (excluding battery)
Accessories	LR6 (AA) alkaline batteries × 6, Strap, Compact flash card (16 MB)

Clamp Sensors



Clamp Sensors Index

Wide-band frequency, high-precision, ideal for observing waveforms (for AC / DC)

 3273-50/3276 DC to 50 MHz / 100 MHz 15 A / 30 A maximum 0.1 V / A output φ 5 mm core jaw dia. p.43	 3274 DC to 10 MHz 150 A maximum 0.01 V / A output φ 20 mm core jaw dia. p.43	 3275 DC to 2 MHz 500 A maximum 0.01 V / A output φ 20 mm core jaw dia. p.43	 3272/3269 Power supply for 3273-50, 3274, 3275, 3276 Single sensor (3272) Four sensors (3269) p.43
--	--	---	---

High-precision sensors to view waveforms or to use with power meters (for AC/DC, or AC only)

 9709 DC to 100 kHz 500 A rated 2 V / 500 A output φ36 mm core jaw dia. p.44	 9277 DC to 100 kHz 20 A rated 2 V / 20 A output φ20 mm core jaw dia. p.44	 9278 DC to 100 kHz 200 A rated 2 V / 200 A output φ20 mm core jaw dia. p.44	 9279 DC to 20 kHz 500 A rated 2 V / 500 A output φ40 mm core jaw dia. p.44	 9272-10 10 Hz to 10 kHz 20 or 200 A rated 2 V / 20 or 200 A output φ46 mm core jaw dia. p.44	 9555-10 Power supply for 9270, 9271, 9272-10, 9277, 9278, 9279 Single sensor connectable p.44
---	---	---	--	--	---

For power lines (50/60 Hz use)

Conversion Adapter

 9010-50 40Hz to 1kHz 10A to 500A range 200mV / range output φ46mm core jaw dia. p.44	 9018-50 40Hz to 3kHz 10A to 500A range 200mV / range output φ46 mm core jaw dia. p.44	 9132, 9132-10 40Hz to 1kHz 20A to 1000A range 200mV / range output φ55 mm core jaw dia.	 9657-10/9675 9657-10 LEAK CLAMP ON SENSOR AC 25mV/A Up to φ40mm 9675 LEAK CLAMP ON SENSOR AC100mV/A Up to φ30mm	 9290-10 AC current up to 1500 A, secondary current 1/10 of primary, φ55 mm dia. or 88 mm width Superior phase angle characteristics	 CT-101A AC current up to 15 A, secondary current 1/1 or 10 times of primary, φ25 mm dia.
--	---	--	--	--	---

Clamp Sensors for 3169/3196 Power meters Clamp Sensors for 8205-10/8206-10, 3636-20

 9660 45Hz to 5kHz (±1%) AC current up to 100A AC 1mV / A output p.34	 9661 45Hz to 5kHz (±1%) AC current up to 500A AC 1mV / A output p.45	 9667 10Hz to 20kHz (±3dB) AC current up to 5000/500A AC 0.1mV / A, AC 1mV / A output p.45	 9669 40Hz to 1kHz (2.0%) AC current up to 1000 A AC 0.5mV / A output p.45	 9650 40Hz to 1kHz (±8%) AC current up to 100A Secondary current 100mA AC p.45	 9651 40Hz to 1kHz (±3%) AC current up to 500A Secondary current 500mA AC p.45	 9668 40Hz to 1kHz (±3%) AC current up to 1000A Secondary current 1000mA AC p.45
---	---	--	--	---	---	--

CLAMP ON PROBE | 3273-50 | 3274 | 3275 | 3276

POWER SUPPLY | 3269/3272

Wide-range current probe allows direct input to oscilloscope

- 3273-50/3276: Wide Band from DC to 50/100 MHz, For Large Current Measurements (30 A rms)
- 3274/3275: Wide Band from DC to 10/2 MHz, For Large Current Measurements (150/500 A rms)



CLAMP ON PROBE : 3276
Wide-band model from DC to 100 MHz

SPECIFICATIONS

	3273-50	3276	3274	3275
Frequency bandwidth	DC to 50MHz (-3dB)	DC to 100 MHz (-3dB)	DC to 10MHz (-3dB)	DC to 2MHz (-3dB)
Rise time	7 ns or less	3.5 ns or less	35 ns or less	175 ns or less
Continuous maximum input range	30A rms	30A rms	150A rms	500A rms
Maximum peak current	Non-continuous 50A peak	Non-continuous 50 Apeak	Non-continuous 300A peak 500A peak at pulse width of $\leq 30\mu s$	Non-continuous 700A peak
Output voltage rate	0.1V/A	0.1V/A	0.01V/A	0.01V/A
Amplitude accuracy	$\pm 1.0\%$ rdg. ± 1 mV (0 to 30 A) (DC, 45 to 66Hz)	$\pm 1.0\%$ rdg. ± 1 mV (0 to 30 A) (DC, 45 to 66 Hz)	$\pm 1.0\%$ rdg. ± 1 mV (0 to 150A /DC, 45 to 66Hz) $\pm 2.0\%$ rdg. (150A to 300A peak / DC, 45 to 66Hz)	$\pm 1.0\%$ rdg. ± 5 mV (0 to 500A /DC, 45 to 66Hz) $\pm 2.0\%$ rdg. (500A to 700A peak / DC, 45 to 66Hz)
Noise	2.5mA rms or less (measured with 20MHz bandwidth equipment)	2.5mA rms or less (measured with 20MHz bandwidth equipment)	25mA rms or less (measured with 20MHz bandwidth equipment)	25mA rms or less (measured with 20MHz bandwidth equipment)
Sensitivity temperature characteristics	Within $\pm 2\%$ (from 0 to 40°C)	Within $\pm 2\%$ (from 0 to 40°C)	Within $\pm 2\%$ (At 55Hz/150A input, 0 to 40°C)	Within $\pm 2\%$ (At 50Hz/500A input, 0 to 40°C)
Maximum rated	5.6VA	5.3 VA	5.5VA (Input within the maximum input range.)	7.2VA (Input within the maximum input range.)
Power supply voltage	$\pm 12V \pm 0.5V$	$\pm 12 V \pm 0.5 V$	$\pm 12V \pm 1V$	$\pm 12V \pm 0.5V$
Ambient conditions for usage	0 to 40°C, max. 80% rh (no condensation)	0 to 40°C, 80% rh or less (no condensation)	0 to 40°C, max. 80% rh (no condensation)	0 to 40°C, max. 80% rh (no condensation)
External magnetic field resistance	Max. 20mA (equivalent) (DC and 60Hz, Magnetic field of 400A/m)	Max. 5 mA (equivalent) (DC and 60 Hz, Magnetic field of 400 A/m)	Max. 150mA (equivalent) (DC and 60Hz, Magnetic field of 400A/m)	Max. 800mA (equivalent) (DC and 60Hz, Magnetic field of 400A/m)
Maximum voltage in measurement circuit	300V, CAT-I (insulated conductor)	300 V, CAT-I (insulated conductor)	600 V CAT-II, 300 V CAT-III (insulated conductor)	600 V CAT-II, 300 V CAT-III (insulated conductor)
Measurement conductor	Diameter max. 5mm	Diameter max. 5 mm	Diameter max. 20 mm	Diameter max. 20 mm
Dimensions and mass	Sensor: approx. 175W×18H×40D mm; 230g Termination unit: approx. 27W×55H×18D mm	Sensor: approx. 175W×18H×40D mm; 240g Termination unit: approx. 27W×55H×18D mm	Sensor: approx. 176W×69H×27D mm; 500g Termination unit: approx. 27W×55H×18D mm	Sensor: approx. 176W×69H×27D mm; 520 g Termination unit: approx. 27W×55H×18D mm
Cable length	Sensor cable: approx. 1.5 m (BNC connector) Power cable: approx. 1 m	Sensor cable: approx. 1.5 m (BNC connector) Power cable: approx. 1 m	Sensor cable: approx. 2 m (BNC connector) Power cable: approx. 1 m	Sensor cable: approx. 2 m (BNC connector) Power cable: approx. 1 m
Supplied accessories	Soft case 1	Hard case 1	Hard case 1	Hard case 1

Clamp Sensors

● **Optional accessories**

POWER SUPPLY 3269/3272

Please specify voltage when ordering for use with 120 V, 220 V, or 240 V.

Use the 3269/3272 power supply for general measurements or when power is not available from the oscilloscope.



3269 (Four sensors)

3272 (Single sensor)

CLAMP ON PROBE 3273-50, 3274, 3275, 3276

3269/3272 SPECIFICATIONS

Suitable sensor model	3273-50, 3274, 3275, 3276 CLAMP ON PROBE
Number of power supply connectors	1 (3272), 4 (3269) (connector type: LEMO inc./ FFA..0S.304.CNAC42Z)
Output voltage	$\pm 12 V \pm 0.5 V$
Ambient conditions for usage	0 to 40°C, max. 80%rh (no condensation)
Power requirements	Please specify voltage when ordering for use with 120V, 220V, or 240V.
Maximum rated power consumption	20VA max. (3272) 170VA max. (3269)
Dimensions and mass	Approx. 73W × 110H × 186D mm; 1.1kg (3272) Approx. 80W × 119H × 200D mm; 1.2kg (3269)
Supplied accessories	Power cord×1, spare fuse×1

UNIVERSAL CLAMP ON CT | 9277 | 9278 | 9279

SENSOR UNIT | 9555-10

High-precision sensors to view waveforms or to use with power meters (for AC/DC)

- Wide frequency ranges including DC
- Use together with the 9555 SENSOR UNIT for current waveform monitoring (with a waveform recorder or oscilloscope)



SPECIFICATIONS

	9277	9278	9279 (Non-CE mark product)
Rated current	20 A AC/DC (continuous 50 A)	200 A AC/DC (continuous 350 A)	500 A AC/DC (continuous 650 A)
Frequency band width	DC to 100 kHz (±5 % f.s.)	DC to 100 kHz (±5 % f.s.)	DC to 20 kHz (±5 % f.s.)
Accuracy (DC or 45 to 66 Hz)	±0.5 % rdg. ±0.05 % f.s., phase ±0.2°	±0.5 % rdg. ±0.05 % f.s., phase ±0.2°	±0.5 % rdg. ±0.05 % f.s., phase ±0.2°
Output rate (with the 9555)	2 V/rated current range (waveform output, with the 9555-10)	2 V/rated current range (waveform output, with the 9555-10)	2 V/rated current range (waveform output, with the 9555-10)
Max. circuit voltage	600 V peak (insulated wire)	600 V peak (insulated wire)	600 V peak (insulated wire)
Core jaw dia.	φ20 mm	φ20 mm	φ40 mm
Power supply	9555-10 SENSOR UNIT (required)	9555-10 SENSOR UNIT (required)	9555-10 SENSOR UNIT (required)
Dimensions, mass	176W×63H×34D mm, 430 g, cord length: 3 m	176W×63H×34D mm, 430 g, cord length: 3 m	220W×103H×43.5D mm, 860 g, cord length: 3 m
Accessories	9375 CARRYING CASE (1)	9375 CARRYING CASE (1)	9375 CARRYING CASE (1)

AC/DC CURRENT SENSOR | 9709

Measure with Absolute Precision

- High current measurement
- Wide DC to 100kHz frequency range



SPECIFICATIONS

Rated current	500A AC/DC
Output voltage	2V/500A
Maximum input current	700A rms (1000A peak, 50/60 Hz, continuous)
Output resistance	50 Ω
Amplitude precision	DC < f < 45 Hz : ±0.2% rdg. ± 0.02% f.s. (DC < f < 5 Hz is reference value) DC, 45 Hz ≤ f < 66 Hz : ±0.05% rdg. ±0.01% f.s. 66 Hz ≤ f < 500 Hz : ±0.2% rdg. ±0.02% f.s. 500 Hz ≤ f < 5 kHz : ±0.5% rdg. ±0.05% f.s. 5 kHz ≤ f < 10 kHz : ±2.0% rdg. ±0.10% f.s. 10 kHz ≤ f < 20 kHz : ±5.0% rdg. ±0.10% f.s. 20 kHz ≤ f < 100 kHz : ±30% rdg. ±0.10% f.s.
Phase precision	DC < f < 45 Hz : ±0.3 deg (No stipulation for DC accuracy, DC < f < 20 Hz is design value) 45 Hz ≤ f < 66 Hz : ±0.2 deg 66 Hz ≤ f < 5 kHz : ±0.5 deg 5 kHz ≤ f < 10 kHz : ±2.0 deg 10 kHz ≤ f < 20 kHz : ±5.0 deg 20 kHz ≤ f < 100 kHz : ±30 deg

Temperature coefficient	Amplitude sensitivity: ±0.01% rdg./°C or less Offset voltage ±0.005% f.s./°C or less
Effect of conductor position	±0.05% or less (when using 100A DC input, and cable with an external diameter of 10 mm(0.39"))
Effect of external magnetic field	50mA or less (400A/m, 60 Hz and a DC magnetic field)
Effect of magnetization	20mA or less (after 500A DC input)
Maximum rated voltage against ground	1000V AC/DC (50/60 Hz) (measurement category III)
Measurable conductor diameter	36 mm(1.42") or less
Supply voltage	DC ±11 V to ±15 V (tracking)
Power consumption	5 VA or less (during 500A DC measurement, with ±12 V power supply)
Dimensions/weight	160 W(6.30") × 112 H(4.41") × 50 D(1.97")mm, 850 g(30.0oz.)
Cord length	3 m(9.84ft)
Accessories	Mark bands (6)

Clamp Sensors

CLAMP ON PROBE | 9010-50 | 9018-50 | 9272-10 | 9555-10

New & Improved

CONVERSION ADAPTER 9704
Receiving: BNC male
Output: Banana female

9010-50
40 Hz to 1 kHz
10 A to 500 A range
200 mV / range output
φ46 mm core jaw dia.

9018-50
40 Hz to 3 kHz
10 A to 500 A range
200 mV / range output
φ46 mm core jaw dia.

9272-10
1 Hz to 100 kHz
20 or 200 A rated
2 V / 20 or 200 A output
φ46 mm core jaw dia.

SENSOR UNIT 9555-10
Power supply for the 9277 / 9278 / 9279, and the 9270 / 9271 / 9272 / 9272-10 / 9709
Single sensor connectable
AC ADAPTER 9418-15

Clamp On Sensors

For power line current measurement
Output voltage (3196, 3197, 3169s, 8800s)

SPECIFICATIONS



MODEL	9694	9660	9661	9669	9667
	 CAT III 300V	 CAT III 300V	 CAT III 600V	 CAT III 600V	 CAT III 1000V
Primary current rating	AC5 A	AC100 A	AC500 A	AC1000 A	AC500 A / 5000 A
Maximum input (45 to 66 Hz)	50 A continuous	130 A continuous	550 A continuous	1000 A continuous	10000 A continuous
Output voltage	AC10 mV/A	AC1 mV/A	AC1 mV/A	AC0.5 mV/A	AC500 mV f.s.
Accuracy Amplitude (45 to 66 Hz) Phase (45Hz to 5kHz)	$\pm 0.3\% \text{rdg} \pm 0.02\% \text{f.s.}$ within $\pm 2^\circ$	$\pm 0.3\% \text{rdg} \pm 0.02\% \text{f.s.}$ within $\pm 1^\circ$	$\pm 0.3\% \text{rdg} \pm 0.01\% \text{f.s.}$ within $\pm 0.5^\circ$	$\pm 1.0\% \text{rdg} \pm 0.01\% \text{f.s.}$ within $\pm 1^\circ$	$\pm 2.0\% \text{rdg} \pm 1.5\% \text{mV}$ (for input 10% or more of the range) within $\pm 1^\circ$ (minimum 10% input)
Frequency characteristic	within $\pm 1.0\%$ at 40 Hz to 5 kHz (9669: within $\pm 2.0\%$)				within $\pm 3\text{dB}$ at 10Hz to 20 kHz
Max. rated voltage to earth	300 V rms		600 V rms		1000 V rms
Measurable conductor diameter	Less than ϕ 15 mm		Less than ϕ 46 mm	ϕ 55 mm, 80 × 20 mm	Less than ϕ 254 mm
Power supply	—				LR03 alkaline battery × 4 (continuous operation max. 168 hours) or AC adapter 9445 (option)
Dimensions and weight	46W × 135H × 21D mm, 230 g		77W × 151H × 42D mm, 360 g	99.5W × 188H × 42D mm, 590 g	Sensor: 910 mm long, 240g, Circuit: 57W × 86H × 30D mm, 140g
	Cord length : 3 m, Output terminal : BNC terminal				

● 9667 OPTION AC ADAPTER 9445 (DC 9 V/1 A output)

f.s. is the sensor's rated primary current value.

For power line current measurement
Output voltage (2300, 3169s)



SPECIFICATIONS

MODEL	9695-02	9695-03	9661-01
	 2331/3169 CAT III 300V	 2331/3169 CAT III 300V	 2331 CAT III 600V
Primary current rating	AC50 A	AC100 A	AC500 A
Maximum input (45 to 66 Hz)	60 A continuous	130 A continuous	550 A continuous
Output voltage	AC10 mV/A	AC1 mV/A	
Accuracy Amplitude (45 to 66 Hz) Phase (45Hz to 5kHz)	$\pm 0.3\% \text{rdg} \pm 0.02\% \text{f.s.}$ within $\pm 2^\circ$	$\pm 0.3\% \text{rdg} \pm 0.02\% \text{f.s.}$ within $\pm 1^\circ$	$\pm 0.3\% \text{rdg} \pm 0.01\% \text{f.s.}$ within $\pm 0.5^\circ$
Frequency characteristic	within $\pm 1.0\%$ at 40 Hz to 5 kHz		
Max. rated voltage to earth	300 V rms		600 V rms
Measurable conductor diameter	Less than ϕ 15 mm		Less than ϕ 46 mm
Power supply	—		
Dimensions and weight	51W × 58H × 19D mm, 50 g Output terminal : M3 terminal Option: Connection cable 9219		77W × 151H × 42D mm, 360 g Cord length : 3 m

f.s. is the sensor's rated primary current value.

● 9695 OPTION CONNECTION CABLE 9219 (for 3169, 3m)

ZCT type leak current sensor
Output voltage
SPECIFICATIONS

MODEL	9657	9658	9675
	 9657-10* CAT III 300V	 CAT III 150V	 CAT III 300V
Primary current rating	AC1 A (9657-10; AC 10A)		AC10 A
Maximum input (45 to 66 Hz)	AC60 A continuous (+10: AC30A continuous)	30 A continuous	10 A continuous
Output voltage	AC25 mV/A (9657-10: AC100 mV/A)		AC100 mV/A
Amplitude Accuracy (45 to 66 Hz)	$\pm 1.0\% \text{rdg} \pm 12\ \mu\text{V}$	$\pm 3.5\% \text{rdg} \pm 12\ \mu\text{V}$	$\pm 1.0\% \text{rdg} \pm 0.5\ \text{mA}$
Residual current	5 mA	1 mA	1 mA
Effect of external magnetic fields	Equivalent to 5mA, 7.5A max. (with a magnetic field of 400 A/m. AC)		
Max. rated voltage to earth	300 V rms	150 V rms	300 V rms
Measurable conductor diameter	Less than ϕ 40 mm	Less than 12 mm × 30 mm	Less than ϕ 30 mm
Power supply	—		
Dimensions and weight	74W × 145H × 42D mm, 340 g (-10: 380 g)	65W × 52H × 18D mm, 100 g	60W × 112.5H × 23.6D mm, 160 g
	Cord length : 3 m, Output terminal : 2P plug (for 3638)		Cord length : 3 m, BNC

For power line current measurement
Output current (8205-10, 8206-10, 3636-20)

SPECIFICATIONS

MODEL	9650	9651	9668
	 3636/ 8205-10/8206-10 CAT III 300V	 3636/ 8205-10/8206-10 CAT III 600V	 8205-10/ 8206-10 CAT III 600V
Primary current rating	AC100 A	AC500 A	AC1000 A
Maximum input (45 to 66 Hz)	130 A continuous	600 A continuous	1000 A continuous
Secondary current rating	AC100 mA	AC500 mA	AC1000 mA
Amplitude Accuracy (45 to 66 Hz)	$\pm 1.5\% \text{rdg} \pm 0.03\% \text{f.s.}$		$\pm 3.0\% \text{rdg} \pm 0.03\% \text{f.s.}$
Frequency characteristic	$\pm 8\%$ or better from 40 Hz to 1 kHz		
Max. rated voltage to earth	300 V rms		600 V rms
Measurable conductor diameter	Less than ϕ 15 mm	Less than ϕ 46 mm	ϕ 55 mm, 80 × 20 mm
Power supply	—		
Dimensions and weight	46W × 135H × 21D mm, 200 g	77W × 151H × 42D mm, 340 g	99.5W × 188H × 42D mm, 550 g
	Cord length : 3 m, Output terminal : 2P plug		

f.s. is the sensor's rated primary current value.

Clamp Testers



Clamp Testers Index

Current Meters (for AC only, basic type)

					
<p>3127-10 AC current, up to 300A, φ33 mm dia. 3128-10 AC current, up to 1500A, φ55 mm dia. p.50</p>	<p>3280-10  AC current, up to 1000A, φ33 mm dia., light 100g and slim 16 mm p.48</p>	<p>3280-20  AC current, up to 1000A, φ33 mm dia., light 100g and slim 16 mm True RMS p.48</p>	<p>3281  AC current, up to 600A, φ33mm dia., Multi-function p.49 3282 AC current, up to 1000A, φ46mm dia., Multi-function p.49</p>	<p>3291  60.00A / 600.0A / 1000A φ30mm dia. light 90 g LCD Display reversible p.50</p>	<p>3286-20  Clamp-On Power Meter V,A,W,VA,var, PF,Hz, Harmonics (V, A only) φ55mm dia. or 80mm busbar p.51</p>

Current Meters (for AC/DC, two-way type)

				
<p>3284  DC and AC current, up to 200 A, φ33 mm dia., Multi-function p.49 3285/3285-20 DC and AC current, up to 2000 A, φ55 mm dia., Multi-function p.49</p>	<p>3287  AC/DC current, up to 100 A, φ35 mm dia., True RMS rectifier p.48 3288 AC/DC current, up to 1000 A, φ35 mm dia., Average rectifier p.48</p>	<p>3290/3290-10  DC and AC current, up to 2000A Choice of three sensors 9691/9692/9693 9691 100A φ35mm 9692 200A φ33mm 9693 200A φ55mm p.50</p>	<p>3283  Leak current, high-sensitivity 10mA range 10μA resolution Load current up to 200A, φ40mm dia. p.49</p>	<p>3293  30.00mA / 300.0mA / 6.000A 60.00A / 600.0A / 1000A φ24mm dia. light 120 g LCD Display reversible p.50</p>

Conversion Adapter (for AC only, clamp-on type)

	
<p>9290-10  AC current up to 1500 A, secondary current 1/10 of primary, φ55 mm dia. or 88 mm width Superior phase angle characteristics</p>	<p>CT-101A AC current up to 15 A, secondary current 1/1 or 10 times of primary, φ25 mm dia.</p>

CLAMP ON HiTESTERS

Table of functions

	AC Current ranges	Other current ranges	AC Voltage ranges	Other voltage ranges	Other functions	Analog output Printer output	Accuracy (at 50 or 60Hz)	Frequency characteristics AC current / voltage
3280-10 3280-20 True RMS	42.00 to 1000A AC, 3 ranges 3280-10: Average rectifier effective value 3280-20: Effective value rectifier	None	4,200 to 600V AC, 4 ranges 3280-10 : Average rectifier effective value 3280-20 : Effective value rectifier	DC Voltage range: 420.0mV to 600V DC, 5 ranges	Resistance: 420.0 to 42.00 MΩ, 6 ranges Accuracy: ±2.0% rdg. ±4 dgt. (at 420 to 420 kΩ range) Continuity: 420.0kΩ (Buzzer sounds at approx. 50Ω or less)	None	AC current: ±1.5 % rdg. ±5 dgt. AC voltage: ±2.3 % rdg. ±8 dgt. DC voltage: ±1.3 % rdg. ±4 dgt. Continuity: ±2.0 % rdg. ±6 dgt.	AC voltage: 50 to 500Hz AC current: 50 or 60Hz (3280-10) AC current: 40 to 1kHz (3280-20)
3281 True RMS 3282 True RMS	3281: 30.00 to 600A AC, 3 ranges 3282: 30.00 to 1000A AC, 3 ranges Effective value rectifier	Wave peak value at AC Current 3281: 75.0 to 1000A peak, 3 ranges 3282: 75.0 to 1700A peak, 3 ranges	300.0 or 600V AC, 2 ranges Effective value rectifier	Wave peak value at AC Voltage up to 750 or 1000V peak, 2 ranges	Distortion check: 1 to 5 Crest factor Resistance:1k or 10kΩ range Temperature*: -50 to 150°C Frequency: 30.0 to 1000 Hz Mode: Slow/Peak/C.F./RMS Record mode/Auto-off/ Conduction	None	AC current: ±1% rdg. ±5 dgt. AC voltage: ±1% rdg. ±3 dgt. Peak: ±3% rdg. ±5 dgt. Frequency: ±0.3% rdg. ±1 dgt.	40 to 1000 Hz
3283 True RMS	10.00mA to 200 A AC, 5 ranges Effective value rectifier	None	None	None	Frequency: 10 to 1000 Hz Filter function: 180Hz±30Hz/-3dB	DC, or AC 1V / f.s. (200A range:2V / f.s.) Level output with REC mode Waveform output with MON mode	10m to 10A range: ±1.0 % rdg. ±5 dgt. 200A range: ±1.5 % rdg. ±5 dgt. Frequency: ±0.3 % rdg. ±1 dgt.	40 to 2kHz
3284 True RMS 3285 True RMS	AC, AC+DC(RMS or Peak value) 3284: 20.00 or 200.0A AC, 2 ranges 3285: 200.0 or 2000A AC, 2 ranges Effective value rectifier	DC (Average or Peak value) 3284: 20.00 or 200.0A DC, 2 ranges 3285: 200.0 or 2000A DC, 2 ranges	AC, AC+DC (RMS or Peak value) 30.00 to 600V AC, 3 ranges Effective value rectifier	DC (Average or Peak value) 30.00 to 600V DC, 3 ranges	Frequency: 1 to 1000Hz Mode: Max./Min./AVE. /RMS Record mode/Auto-off	DC, or AC 1V / f.s. Level output with REC mode Waveform output with MON mode	AC current: ±1.3 % rdg. ±3 dgt. AC voltage: ±1.0 % rdg. ±3 dgt. Frequency: ±0.3 % rdg. ±1 dgt.	3284: DC, 10 to 2kHz 3285: DC, 10 to 1kHz
3286-20 True RMS	20.00 to 1000 A AC, 3 ranges Effective value rectifier	None	150.0/300.0/600 V AC, 3 ranges Effective value rectifier	None	Power(Single-phase or 3 phase): 3kW to 600kW(Single-phase) 6kW to 1200kW(3-phase) Power factor, Phase angle: Frequency: 30.0 to 1000Hz Voltage/current harmonic levels	9442 PRINTER (Option)	AC current: ±1.3 % rdg. ±3 dgt. AC voltage: ±1.0 % rdg. ±3 dgt. Power: ±2.3% rdg. ±5 dgt.(1φ) ±3.0% rdg. ±10 dgt.(3φ) (Accuracy guaranteed only for 50/60Hz cosφ=1)	AC current: 45 to 1kHz AC voltage: 30 to 1kHz
3287 True RMS 3288	3287: 10.00 or 100.0A AC, 2 ranges Effective value rectifier 3288: 100.0 or 1000A AC, 2 ranges Average rectifier effective value	DC mode 3287: 10.00 or 100.0 A DC, 2 ranges 3288: 100.0 or 1000 A DC, 2 ranges	3287: 4,200 to 600V AC, 4 ranges Effective value rectifier 3288: 4,200 to 600V AC, 4 ranges Average rectifier effective value	DC mode 420.0 mV to 600 V DC, 5 ranges	Resistance: 420.0 to 42.00MΩ, 6 ranges Accuracy: ±2.0% rdg. ±4 dgt. (at 420 to 420kΩ range) Continuity: 420.0Ω (Buzzer sounds at approx. 50Ω or less)	None	AC current: ±1.5 % rdg. ±5 dgt. AC voltage: ±2.3 % rdg. ±8 dgt. DC voltage: ±1.3 % rdg. ±4 dgt. DC current: ±1.5 % rdg. ±5 dgt. Continuity: ±2.0 % rdg. ±6 dgt.	AC current: 3287 DC, 10 to 1kHz AC current: 3288 DC, 10 to 500Hz AC voltage: 30 to 500Hz
3290 True RMS 3290-10 True RMS	3290+9691 : AC 20 to 100A 3290+9692 : AC 20 to 200A 3290+9693 : AC 200 to 2000A AC+DC, AC RMS, AC MEAN	3290+9691 : DC 20 to 100A 3290+9692 : DC 20 to 200A 3290+9693 : DC 200 to 2000A	None	None	Frequency : 10 to 1000 Hz	DC, or AC Current : 2V/f.s. Level output with REC mode Waveform output with MON mode Integ./Frequency : 1V/f.s.	AC/DC/AC+DC Current ±1.3 % rdg. +3 dgt. (Typical) Frequency : ±0.3 % rdg. +1 dgt. (Typical)	DC to 500Hz (9691) DC to 1kHz(9692, 9693) ±2.3 % rdg. + 8 dgt.
3127-10 3128-10	3127: 6 to 300A AC, 5 ranges 3128: 15 to 1500A AC, 5 ranges Average rectifier effective value	None	150 to 750V AC, 3 ranges Average rectifier effective value	DC Voltage range: 75 V DC, 1 range	Resistance: 1k or 100kΩ range Temperature*: -50 to 200°C *9021-01 TEMPERATURE PROBE required, (sold separately)	None	AC current: ±3% f.s. AC/DC voltage: ±3% f.s.	50 or 60 Hz

	Display	Sampling rate	Crest factor (RMS)	Effect of external magnetic fields	Max. circuit voltage	Core jaw dia.	Power supply	Dimensions/mass	Included accessories
3280-10 3280-20 True RMS	Digital /LCD, maximum 4199 dgt.	2.5 times /sec or 1 time /3 sec	None (3280-10) 2.5 (3280-20)	No provision	600V AC rms	φ33 mm	CR2032 (3 VDC) ×1	57W×175H× 16D mm /100 g	TEST LEAD 9208 (1) CARRYING CASE 9398 (1)
3281 True RMS 3282 True RMS	Digital /3000 dgt. Bar graph /35 seg.	2 or 4 times /sec (Slow: 1 time /3 sec)	2.5 (1.7 at 600A, 1000A, 600 V range)	3281: 1.5A equivalent max. at 400 A/m 3282: 0.2A equivalent max. at 400 A/m	600V AC rms (insulated wire)	3281: φ33 mm 3282: φ46 mm	6F22(006P) ×1	3281: 62W×218H× 39D mm /350 g 3282: 62W×230H× 39D mm /400 g	TEST LEAD 9207-10(1) CARRYING CASE 9399 (1) Hand strap(1)
3283 True RMS	Digital /2000 dgt. Bar graph /35 seg.	2 or 4 times /sec (Slow: 1 time /3 sec)	2.5 (1.5 at 200A range)	corresponds to 5mA, max. 7.5 mA equivalent max. at 400A/m	300 V AC rms (insulated wire)	φ40 mm	6F22(006P) ×1 or AC adapter	62W×225H×39D mm/400 g	CARRYING CASE 9399 (1) Hand strap(1)
3284 True RMS 3285 True RMS	Current / 2500 dgt. Voltage / 3750 dgt. Bar graph /35 seg.	2 or 4 times /sec (Slow: 1 time /3 sec)	2.5 1.5 (3284: 200A range), 1.42 (3285: 2000A range)	3284: 0.5A equivalent max. at 400 A/m 3285: 2.0A equivalent max. at 400 A/m	600V AC rms (insulated wire)	3284: φ33 mm 3285: φ55 mm	6F22(006P) ×1 or AC adapter	3284: 62W×230H× 39D mm /460 g 3285: 62W×260H× 39D mm /540 g	TEST LEAD 9207-10(1) CARRYING CASE (1 for 3284) 9399 CARRYING CASE (1 for 3285) 9345 Hand strap(1)
3286-20 True RMS	Digital /LCD, maximum 6000 dgt.	Normal: 1 time /sec (Slow: 1 time /3 sec)	2.5 (1.7 at 1000 A, 600 V range)	1.00 A equivalent max. at 400 A/m	600 V AC rms (insulated wire)	φ55 mm or 80mm busbar	6LR61/6LF22 (006P) ×1	100W×287H×39D mm /650 g	VOLTAGE CORD 9635 (1) CARRYING CASE 9245 (1) Hand strap(1)
3287 True RMS 3288	Digital /LCD, maximum 4199 dgt.	2.5 times /sec	3287 2.5 or less (150A, 1000V maximum) 3288 None	No provision	600 V AC rms (insulated wire)	3287: φ35 mm 3288: φ35 mm	CR2032 (3VDC) ×1	3287: 57W×180H× 16D mm /170 g 3288: 57W×180H× 16D mm /150 g	TEST LEAD 9208(1) CARRYING CASE 9398 (1)
3290 True RMS 3290-10 True RMS	Digital / LCD maximum 3000 dgt. Bar graph / 20 seg. 3290-10 maximum 9999 dgt.	Fast : 4 times / sec, (3290-10) FAST : 10 times/sec Normal : 2 times / sec, Slow : 1 time / 3sec	2.5 or less	9691 : 0.5 A equivalent max. at 400 A/m 9692 : 0.7 A equivalent max. at 400 A/m 9693 : 2.0 A equivalent max. at 400 A/m	600 V AC rms (insulated wire)	9691 : φ55mm 9692 : φ53mm 9693 : φ55mm	Type 3 alkaline dry cell (LR6) ×4 or AC adapter	3290 : 155W×98H× 47D mm / 545g 9691 : 53W×129H× 18D mm / 230g 9692 : 62W×167H× 35D mm / 410g 9693 : 62W×196H× 35D mm / 500g	strap
3127-10 3128-10	Indicator type	None	None	No provision	600V AC rms (insulated wire)	3127: φ33 mm 3128: φ55 mm, or 80 mm busbar	R6P(AA) ×1	3127-10: 78W×190H× 34D mm /340 g 3128-10: 99W×237H× 34D mm /570 g	TEST LEAD 9067 (1) CARRYING CASE (for 3127) 9351(1) CARRYING CASE (for 3128) 9148 (1)

CLAMP ON HiTESTER | 3280-10



Easy operation !

- 1000 A clamp aperture: 33 mm dia.
- Light 100 g, and Slim 16 mm
- Independent-opening double-lever design
- Slim body allows easy clamping even for narrow conductors
- No metal (iron core) exposure, ensuring enhanced safety



CAT III 600 V
(Current range)
CAT II 600 V
(Voltage range)

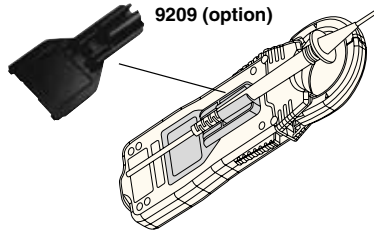

OPTIONS

TEST LEADS HOLDER 9209
*CT-101A LINE SPLITTER

**Note: Non-CE mark product*

CLAMP ON HiTESTER | 3280-20

True RMS !

- 1000 A rms, clamp aperture: 33 mm dia.
- Light 100 g, and Slim 16 mm
- Independent-opening double-lever design
- Slim body allows easy clamping even for narrow conductors
- No metal (iron core) exposure, ensuring enhanced safety



CAT III 600 V
(Current range)
CAT II 600 V
(Voltage range)



True RMS



OPTIONS

TEST LEADS HOLDER 9209
*CT-101A LINE SPLITTER

**Note: Non-CE mark product*



CLAMP ON AC/DC HiTESTER | 3287 | 3288

Compact & easy, one-touch maintenance on all types of AC/DC equipment

- The 3287 can handle even cogenerator / inverter energy-saving equipment (10/100A)
- Use the 3288 for high current measurements such as UPS emergency batteries and train motors (100/1000A)
- A slim core of only 10 mm (0.39") for easy clamping even in crowded wiring



CAT III 600 V
(AC/DC A)
CAT II 600 V
(AC/DC V)



True RMS

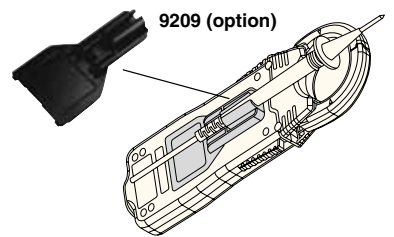

OPTIONS

TEST LEADS HOLDER 9209
*CT-101A LINE SPLITTER

**Note: Non-CE mark product*



DIGITAL CLAMP ON HiTESTER

3281 | 3282

True RMS is shown in the distorted waveform

- 3281: 600 A AC, ϕ 33 mm 3282: 1000 A AC, ϕ 46 mm
- AC Current/Voltage, Frequencies, Resistance, Conduction check, Temperature (probe sold separately)
- CAT IV 600V
- Auto-power off to prevent the power from being left on
- Non-fuse type protects up to 600 V AC



OPTIONS

THERMISTOR TEMPERATURE PROBE *9462
 *CT-101A LINE SPLITTER

*Note: Non-CE mark product

CLAMP ON LEAK HiTESTER | 3283

Easily monitor leak current fluctuations

- High-sensitivity with a full scale of 10mA (resolution:10 μ A)
- High-accuracy at \pm 1%
- True RMS measurement
- Analyzer functions, for filtering and output signals
- Wide bandwidth, 5Hz to 15kHz (Monitor output)

OPTIONS

AC ADAPTER (for USA) 9445-02
 AC ADAPTER (for EU) 9445-03
 CLAMP ON ADAPTER 9290-10
 *CT-101A LINE SPLITTER
 (cannot be used for leakage current, for use on load current only)
 OUTPUT CORD *9094
 BNC TO BANANA ADAPTER 9199

*Note: Non-CE mark product

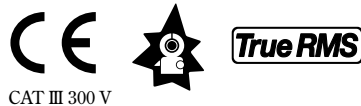

CLAMP ON AC/DC HiTESTER

3284 | 3285 | 3285-20

Analysis for DC to distorted waves

- 3284: 200 Arms, clamp aperture: 33 mm dia.
- 3285: 2000 Arms, clamp aperture: 55 mm dia.
- 3285-20: With resistance measurement range
 No analog output
 Cannot be used with AC adapter
- Inrush current crest value
- RMS value of full-wave rectified waveforms
- Waveform and harmonic analysis



OPTIONS

AC ADAPTER (for USA) 9445-02 *CT-101A LINE SPLITTER (cannot be used for DC,
 AC ADAPTER (for EU) 9445-03 AC+DC current, for use on AC current only)
 CLAMP ON ADAPTER 9290-10 OUTPUT CORD *9094
 BNC TO BANANA ADAPTER 9199

*Note: Non-CE mark product

CLAMP ON HiTESTER | 3291 | 3293

New



3291

DIGITAL CLAMP ON HiTESTER

3291

Flip Clamp !



SPECIFICATIONS

AC Current range	60.00 A / 600.0 A / 1000 A AC (3 ranges) Filter on : ±1.5 % rdg. ±5 dgt. at 50 or 60Hz Filter off : ±2.0 % rdg. ±5 dgt. at 45 to 60Hz Filter off : ±3.0 % rdg. ±5 dgt. at 40 to 45Hz, 66 to 600Hz
Other functions	Filter on/off (180Hz, -3dB), Display hold, Max. value hold, Auto power off, LCD Display reversible
Frequency characteristics	40 to 600 Hz
Sampling rate	2 times/sec (Bar graph: 4 times/ sec)
Crest factor (RMS)	2.0 (600 A and under) 1.5 and under (600A over)
Core jaw dia.	φ30 mm
Power supply	CR2032x 1
Dimensions, mass	50 mm W x 136 mm H x 26 mm D, 90 g
Accessories	CARRYING CASE 9757 (1), strap (1)

New

CLAMP ON LEAK HiTESTER 3293

Flip Clamp !



3293

SPECIFICATIONS

AC Current range	30.00 mA / 300.0 mA / 6000A / 60.0A / 600.0A / 1000 AAC (Auto range) Filter on : ±1.5 % rdg. ±5 dgt. at 50 or 60Hz Filter off : ±2.0 % rdg. ±5 dgt. at 45 to 60Hz Filter off : ±3.0 % rdg. ±5 dgt. at 40 to 45Hz, 66 to 600Hz
Other functions	Filter on/off (180Hz, -3dB), Display hold, Max. value hold, Auto power off, LCD Display reversible
Frequency characteristics	40 to 600 Hz
Sampling rate	2 times/sec (Bar graph: 4 times/ sec)
Crest factor (RMS)	2.0 (600 A and under) 1.5 and under (600A over)
Core jaw dia.	φ24 mm
Power supply	CR2032x 1
Dimensions, mass	50 mm W x 130 mm H x 26 mm D, 120 g
Accessories	CARRYING CASE 9757 (1), strap (1)



Flip clamp
Display reversible

CLAMP ON AC/DC HiTESTER | 3290/3290-10

CLAMP ON AC/DC SENSOR | 9691 | 9692 | 9693

All the Functions You Need for Measurement at DC or 1Hz and Up

- Choice of three sensors (Example combinations)
3290+9691 : Measure up to 100A (φ35mm)
3290+9692 : Measure up to 200A (φ33mm)
3290+9693 : Measure up to 2000A (φ55mm)
- Choice of measurement methods
DC (for battery measurement)
AC+DC RMS (for full-/half-wave rectification measurement)
AC RMS (for current distortion measurement)
PEAK (for peak value measurement) of inrush current, etc.)
- Choice of output (Simultaneous output)
Effective value output, frequency output, waveform output
- Choice of response times (Switchable among three response times)
- LPF function (filters out unnecessary harmonics : fc=550Hz)
- 3290-10 Functions
Current integral measurement (obtain polarity-specific integrated DC values)
Operating time/duty measurement



3290-10

9692

3290

9691



CLAMP ON HiTESTER | 3127-10 | 3128-10



One meter drop-proof "Tested Tough!"

- With the range of 300 A (3127-10), 1500 A (3128-10)
- Temperature measurement
- Ohmmeter circuit tested to 250 V AC over voltage-OK
- Clamp-on measurement for busbars and thick conductors (3128-10)

OPTIONS

THERMISTOR TEMPERATURE PROBE *9021-01
CLAMP ON ADAPTER (for large AC current) 9290-10
*CT-101A LINE SPLITTER

*Note: Non-CE mark product

CLAMP ON POWER HiTESTER 3286-20

**All powerful ! Easy operation !
True-RMS Clamp-on Power Meter !**

- Use as a single-phase power meter or power factor meter (3kW to 600kW range)
- Simple checking of three-phase lines (6kW to 1200kW range)
- Check power supply fluctuations
- 1000 A, 1000 Hz, peak and harmonic measurement
- True RMS (effective value) display method
- Optional printer (9442 PRINTER)



RS-232C
CAT III 600 V

True RMS



RS-232C PACKAGE 9636-01



SPECIFICATIONS

Measurement items	Voltage, current, voltage/current peak, effective/ reactive / apparent power(Single-phase or 3-phase), power factor, reactivity, phase angle, frequency, phase detection(3-phase), voltage/current harmonic levels(up to 20th)
Measurable conductor diameter	φ55mm (2.16") max.
Display	LCD, digital (6000 counts)
Rectification method	RMS (true root mean square value)
Display update rate	NORMAL approx. 1 time/ sec, SLOW 1 time/ 3-sec at HARM meas. approx. 1 time/ 2-sec
Analog response time	4 seconds or less (when input is changed from 0% to 90% of range.)

Voltage/ Current/ Power measurement

Range Table		AC Current			
		20.00 A	200.0 A	1000 A	
AC Voltage	150.0 V	Single-phase	3.000 kW	30.00 kW	150.0 kW
		*3-phase(balanced load)	6.000 kW	60.00 kW	300.0 kW
	300.0 V	Single-phase	6.000 kW	60.00 kW	300.0 kW
		*3-phase(balanced load)	6.000/12.00 kW	60.00/120.0 kW	600.0 kW
	600 V	Single-phase	12.00 kW	120.0 kW	600.0 kW
		*3-phase(balanced load)	24.00 kW	240.0 kW	600.0/1200 kW

*3-phase power is calculated and displayed on the basis of a balanced, 50/60 Hz, sine wave input. For apparent power and reactive power, the unit of wats in the above table is replaced by VA and var respectively.

Effective value P.F.	0.000 (lead) to 1.000 to 0.000 (lag); 1φonly
Max. allowable current	1000 Arms cont.
Max. usable circuit voltage	600 Vrms (insulated conductor)
Effective input range	Voltage: 10 V to 600 V, Current: 10 A to 1000A, Power: 80 V to 600 V and 10 A to 1000 A
Min. Display value	Voltage: 0.6 Vrms, Current: 0.6 Arms
Display indication range (RMS value)	5 or less are zero-suppressed, and the upper limit is to 125% of the range setting (to 100% for the 1000 A range)
Circuit dynamic	2.5 or less (1000 A and 600 V range is 1.7 or less)

Power factor/ Phase angle/ Reactivity measurement

Detection method	Phase discrimination by phase detection (zero crossing)
Power factor (cos φ)	0.000 (lead) to 1.000 to 0.000 (lag)
Phase angle	90.0°(lead) to 0.0°to 90.0°(lag)
Reactivity (sin φ)	0.000 (lead) to 1.000 to 0.000 (lag)

Frequency measurement

Effective in the voltage and current functions

Measurement range	30.0 Hz to 100 Hz (at 100.0Hz range) 100 Hz to 1000Hz (at 1000Hz range)
Min. input level	Voltage 10 Vrms-sine wave, Current 1 Arms-sine wave

Wave peak measurement

Effective in the voltage and current functions

Measurement range	150 (375 peak) / 300 (750 peak) / 600 (1020 peak) V 20 (50 peak) / 200 (500 peak) / 1000 (1700 peak) A
Effective Input Range	Effective value of sine wave is within effective input permissible in the range and within circuit dynamic

Harmonic measurement

Effective in the voltage and current functions

Measurement items	Level of each order, percentage of each order and total harmonic distortion (THD-F and THD-R)
Measurement range	Fundamental frequency 45 Hz to 65 Hz
Window width	1 cycle (45 Hz to 65 Hz), Data points: 256 points
Window type	Rectangular
Orders analyzed	Up to 20th

Other functions

Phase detection	Normal/ reverse/ missing (at 3-phase balanced load)
Record	MAX. value and MIN. value (Effective in the voltage, current and effective / apparent power functions)
Battery capacity	Displayed in % when the unit is powered on
Data hold	Holds display
Auto power off	Approx. 10 minutes, buzzer sounds just before power is turned off, can be extended or cancelled
Data output	RS-232C interface by optical insulating coupler

OPTIONS

RS-232C PACKAGE	9636-01	AC ADAPTER (for 9442 printer, EU)	9443-02	VOLTAGE CORD	9635
PRINTER	9442	AC ADAPTER (for 9442 printer, America)	9443-03		
RS-232C CABLE (for 9442 printer)	9636	RECORDING PAPER (for 9442 ,10 rolls)	1196		

Field Measuring Instruments



Field Measuring Instruments Index

Analog Multi Meters



3030-10 
Basic type analog tester,
Average rectifier
..... p.59



3008
Use for industrial power lines
Average rectifier



3665-20 
Affordable LAN cable testing, Wire-Map, Cable length, Direction-Check
..... p.60



3661-20, 3662/63-20 
Optical loss measurement tool
LASER LIGHT SOURCE 3662/63-20
..... p.60



3664 
OPTICAL POWER METER
For testing DVD recorders, CD drives, Copiers, laser printers, etc.

Magnetic Field HITESTER



3470 
Magnetic field tester for home appliances
..... p.60

Digital Multi Meters (basic functions)



3246 
Pencil type DMM, Average rectifier
..... p.54



3244 
Card size DMM with emphasis on safety, Average rectifier
..... p.54



3245 
A card size DMM with solar charged battery, Average rectifier



3255-50 
Built tough for use with industrial power lines DMM, Average rectifier
..... p.55



3256-50, -51 
Terminal shutter interlock mechanism DMM, Average rectifier
..... p.55

Phase Detector



3126-01
Phase detector, Rotary disk style, 110 to 480V



3129/3129-10 
Phase Detector, Non-contact types, AC 70 to 600 V(50/60 Hz) AC 70 to 1000V (3129-10)
..... p.58

Digital Multi Meters (multi-functional and high precision)



3257-50, -51 
Terminal shutter interlock mechanism DMM, True RMS rectifier
..... p.55





3801-50 
Multi-function type, 51000 count display, RS-232C/USB communication, True RMS rectifier
..... p.54



3802-50 
Low-cost type, 51000 count display, RS-232C/USB communication, True RMS rectifier



3803  
Low-cost type, 4000 count display, RS-232C communication, Average rectifier
..... p.54





3804-50, 3805-50 
Multi-function type, 9999 count display (V range), RS-232C communication, True RMS rectifier (3805)
..... p.55



3237, 3238, 3239 
High speed DMMs 199999 count display
..... p.32



3120, 3480-21   
Voltage Detector AC 70 to 600 V(50/60 Hz)
3481-21, 3481-22
Bright LED lights
..... p.55

Insulation Testers



3490 ANALOG MΩ HITESTER 
3 insulation resistance ranges, continuity, plus 4000MΩ testing at the 1000V range
Conforms to IEC 61557/60364-6-61



3451-11 to -15 
Testing voltage 125V to 1000V, Single range, Compact and lightweight, Luminous scale indicator type
..... p.57



3452-11 to -13 
Testing voltage 25V to 1000V, Three ranges, Compact and lightweight, Luminous scale indicator type
..... p.57



3453 
Testing voltage 125V to 1000V, Four ranges in one body, Compact and lightweight, Digital display, Comparator and memory function
..... p.56



3454-10/-11/-51 
Innovative and low-cost Insulation resistance tester with continuity function
..... p.57



3455 
Testing voltage 250V to 5000V, Five ranges 10 MΩ to 5 TΩ Seven ranges
..... p.56



3151 
Grounding resistance meter, Two-wire or three-wire measurement method, Tough and durable design
..... p.58

Earth Testers

DIGITAL HiTESTERS

Table of functions

	DC Voltage ranges	AC Voltage ranges	Frequency characteristics at AC Voltage	Resistance ranges	DC Current ranges	AC Current ranges	Frequency characteristics at AC Current	Frequency ranges	Continuity
3244	420mV to 500V, 5 ranges Best accuracy: ±0.7% rdg. ±4 dgt.	4.2V to 500V, 4 ranges Accuracy: ±2.3 % rdg. ±8 dgt. Average rectifier effective value	50 to 500 Hz	420Ω to 42 MΩ, 6 ranges Best accuracy: ±2.0% rdg. ±4 dgt.	None	None	None	None	50Ω ±30Ω
3246	420.0mV to 600V, 5 ranges Best accuracy: ±1.3 % rdg. ±4 dgt.	4.2V to 600V, 4 ranges Accuracy: ±2.3% rdg. ±8 dgt. Average rectifier effective value	50 to 500 Hz	420.0Ω to 42.00MΩ, 6 ranges Best accuracy: ±2.0 % rdg. ±4 dgt.	None	None	None	None	(50Ω±30Ω)
3256-50 3256-51 (3257)	420.0mV to 1000V, 5 ranges Best accuracy: ±0.5% rdg. ±2 dgt.	420.0mV to 1000V, 5 ranges Best accuracy: ±1.2% rdg. ±3 dgt. Average rectifier effective value	50 to 500 Hz	420.0Ω to 42.00MΩ, 6 ranges Best accuracy: ±0.7% rdg. ±2 dgt.	42.00μA to 10.00A, 6 ranges Accuracy: ±1.5 % rdg. ±4 dgt.	42.00μA to 10.00 A, 6 ranges Best accuracy: ±2.5 % rdg. ±5 dgt. Average rectifier effective value	50 to 500Hz	0.50Hz to 500.0kHz, 5 ranges input level: 800mV to 1000V rms Accuracy: ±0.02% rdg. ±1 dgt.	50Ω ±30Ω or less
3801-50 True RMS 3802-50 True RMS	51mV to 1000V, 7 ranges Best accuracy 3801-50: 0.025% rdg. ±5dgt. 3802-50: 0.03% rdg. ±5dgt.	51mV to 1000V, 7 ranges Best accuracy 3801-50: 0.4% rdg. ±25dgt. 3802-50: 0.6% rdg. ±25dgt.	3801-50: 20 to 100kHz 3802-50: 30 to 30kHz	510Ω to 510MΩ, 7(6) ranges (3802-50) Best accuracy 3801-50: 0.05% rdg. ±5 dgt. 3802-50: 0.08% rdg. ±5 dgt.	510μA to 10A, 6 ranges Best accuracy 3801-50: 0.05% rdg. ±25 dgt. 3802-50: 0.1% rdg. ±25 dgt.	510μA to 10A, 6 ranges Best accuracy 3801-50: 0.7% rdg. ±20 dgt. 3802-50: 0.9% rdg. ±25dgt.	3801-50: 20 to 100kHz 3802-50: 30 to 20kHz	99.999Hz to 999.99kHz Best accuracy: 0.02% rdg. ±3 dgt.	10Ω or less (at 510Ω range)
3803	400.0mV to 1000V, 5 ranges Best accuracy: ±0.6% rdg. ±2 dgt.	400.0mV to 1000V, 5 ranges Best accuracy: ±1.2% rdg. ±2 dgt. Average rectifier effective value	40 to 500Hz	400.0Ω to 40.00MΩ, 6 ranges Best accuracy: ±0.6% rdg. ±3 dgt.	400.0μA to 10.00A, 5 ranges Best accuracy: ±1.5 % rdg. ±2 dgt.	400.0μA to 10.00A, 5 ranges Best accuracy: ±2.0 % rdg. ±2 dgt. Average rectifier effective value	40 to 500Hz	None	34.5Ω or less (at 400Ω range)
3804-50	999.9mV to 999.9V, 4 ranges Best accuracy: ±0.09% rdg. ±2 dgt.	999.9mV to 999.9V, 4 ranges Best accuracy: ±1.2 % rdg. ±5 dgt. Average rectifier effective value	40 to 500 Hz	999.9Ω to 99.99MΩ, 6 ranges Best accuracy: ±0.3 % rdg. ±3 dgt.	999.9μA to 9.99A, 5 ranges Best accuracy: ±0.1 % rdg. ±3 dgt.	999.9μA to 9.99A, 5 ranges Best accuracy: ±1.2 % rdg. ±5 dgt. Average rectifier effective value	40 to 2 kHz	None	10Ω or less (at 999.9Ω range)
3805-50 True RMS	999.9mV to 999.9V, 4 ranges Best accuracy: ±0.09 % rdg. ±2 dgt.	999.9mV to 999.9V, 4 ranges Best accuracy: ±1% rdg. ±5dgt. Effective value rectifier	40 to 2 kHz	999.9Ω to 99.99MΩ, 6 ranges Best accuracy: ±0.3 % rdg. ±3 dgt.	999.9μA to 9.99A, 5 ranges Best accuracy: ±0.1% rdg. ±3dgt.	999.9μA to 9.99A, 5 ranges Best accuracy: ±1 % rdg. ±5 dgt. Effective value rectifier	40 to 2kHz	0.5Hz to 999.9kHz / 0.5V to 1000V rms Best accuracy: ±0.03% rdg. ±3 dgt.	10Ω or less (at 999.9Ω range)
3255-50	420mV to 1000 V, 5 ranges, Best accuracy: ±0.5 % rdg. ±4 dgt.	420mV to 1000 V, 5 ranges, Best accuracy: ±1.2% rdg. ±4 dgt. Average rectifier effective value	50 to 500 Hz	420Ω to 42 MΩ, 6 ranges, Best accuracy: ±0.7 % rdg. ±4 dgt.	None	None	None	None	(45Ω ±35Ω or less)
3030-10	0.3V (16.7kΩ/V), 3/12/30/120/300/600V(20kΩ/V) Accuracy: ±2.5% f.s.	12V±4% f.s. (9kΩ/V) 30/120/300/600V ±2.5% f.s. Average rectifier effective value	None	0 to 3kΩ (center scale 30Ω) R×1, R×10, R×100, R×1k ±3.0% of scale length	60μA/30m/300mA (300mV internal voltage drop) Accuracy: ±3% f.s.	None	None	None	None

	Diode check	Other functions	Auto power save	Range switching	Display/Safety	Bar graph display	Sampling rate	Power supply	Dimensions/ mass	Included accessories
3244	None	None	(Cancel impossible)	Auto	Digital/LCD, maximum 4199 dgt Safety: IEC1010-1, Pollution degree 2, over voltage category II	None	2.5 times /sec	CR2032×1 batteries (Continuous use 150 hours)	55W×109H×9.5D mm/60g	Hard case(1)
3246	judgement only (3.4V open terminal voltage)	None	(Cancel possible)	Auto or Manual	Digital/LCD, with Back light max. 4199 dgt.	None	2.5 times/sec	CR2032×1 batteries (Continuous use 150 hours)	30W×182H×26.5D mm 80 g	
3256-50 3256-51 (3257)	(3.4 V open terminal voltage)	Voltage detect function Hold-auto function Relative function	(Cancel possible)	Auto or Manual	LCD, maximum 4200 dgt. (all mode) maximum 19999 dgt. (Frequency)	(Maximum 40 segments)	2.5 times/sec (all mode) 5 times/sec (Frequency) 25 times/sec (Bar graph)	R03(AAA)×2 dry batteries (Continuous use 100 hours)	76W×167H×33D mm/260 g	TEST LEAD 9170(1) Fuse(2) CARRYING CASE 9378 (1) (3256-50) Holster (3256-51)
3801-50 True RMS 3802-50 True RMS	(3.1 V open terminal voltage)	3801-50 only: AC+DC measurement, Pulse output Common functions: Capacitance, Data hold, dBm measurement, Duty ratio/Pulse width, Temperature, 1ms peak hold Relative, Max/Min/Ave, RS-232C, USB	(Cancel possible)	Auto or Manual	LCD, max. 51000 dgt. with Back light	Maximum 21 dots	3.75 times/sec	6LR61×1 (9.0V) (Continuous use 50 hours)	90W×192H×37D mm/940 g	TEST LEAD 3851-10(1), Holster(1)
3803	(3 V open terminal voltage)	RS-232C, Data hold	(Cancel possible)	Auto or Manual	LCD, max. 4200 dgt.	(Maximum 41 dots)	2.5 times/sec 13 times/sec (Bar graph)	6F22(006P)×1	76W×167H×33D mm 400 g	TEST LEAD 3851-10(1) Holster(1)
3804-50	(3.5 V open terminal voltage)	Capacitance, Data hold, Refresh hold, Max/Min/Ave/Relative/4-20mA% display, RS-232C, USB	(Cancel possible)	Auto or Manual	LCD, max. max. 9999 dgt.	(Maximum 41 dots)	7 times/sec (exclusive Ω range) 14 times/sec (Ω range)	6F22(006P)×1 6LR61×1(9.0V) (continuous use 60 hours)	76W×167H×33D mm/390 g	TEST LEAD 3851-10(1) Holster(1)
3805-50 True RMS	(3.5 V open terminal voltage)	Capacitance, Data hold, Refresh hold, Max/Min/Ave/Relative/4-20mA% display, RS-232C, USB Temperature	(Cancel possible)	Auto or Manual	LCD, max. 9999 dgt.	(Maximum 41 dots)	7 times/sec (exclusive Hz and Ω range) 1 time/sec (Hz range) 14 times/sec (Ω range)	6F22(006P)×1 6LR61×1(9.0V) (continuous use 60 hours)	76W×167H×33D mm/400 g	TEST LEAD 3851-10(1) Holster(1)
3255-50	judgement only (3.4 V open terminal voltage)	CLAMP (ACA) function (Clamp-on probe : Option) 10A to 1000A 7ranges	(Cancel possible)	Auto or Manual	LCD, maximum 4199 dgt.	None	2.5 times/sec	R03(AAA)×2 dry batteries (Continuous use 200 hours)	70 mmW×145 mmH×31 mmD/200 g	TEST LEAD 9207-10 (1), CARRYING CASE 9371 (1)
3030-10	(3V open terminal voltage)	Battery check: 0.9 to 1.8V, load resistance 10Ω Temperature: -20 to 150, (Thermister Temperature Probe 9021-01 is necessary, sold separately)	None	Manual	Indicator type	None	None	R6P(AA)×2 batteries	95W×141H×39D mm 280g	TEST LEAD 9207-30(1) fuse(1) CARRYING CASE 9390 (1)

Field Measuring Instruments

PENCIL HiTESTER | 3246

Pencil-type DMM with Penlight

In addition to being compact, this pencil-type tester comes with auto-range and data hold functions for incredibly easy measurement of electrical and electronic circuitry.

- Full-auto ranging, 4199 count display
- Penlight brightly illuminates test points
- Overload protection to 600 V (Ω and continuity functions)



Penlight brightly illuminates test points

OPTIONS

10A SHUNT *9081

*Note: Non-CE mark product

CARD HiTESTER | 3244

Card size DMM with emphasis on safety

- Only 9.5 mm thick and 60 g in weight
- 4199 count display
- Test leads fit neatly inside the case.
- Automatic power saving function saves your batteries even when you forget to turn off the power.

OPTIONS

10A SHUNT *9081

*Note: Non-CE mark product



DIGITAL HiTESTER | 3801-50

High-precision, high-resolution, and multi-functional handy DMMs

- Display two different parameters simultaneously
- Optional RS-232C or USB package for transferring data captured by the 3801-50 to a PC
- Measures the AC components in DC voltage or DC current
- 1ms peak hold mode makes it possible to capture the peak value of a waveform



CAT IV 600 V
CAT III 1000 V



OPTIONS

CARRYING CASE	3853
COMMUNICATION PACKAGE (RS-232C)	3856-01
COMMUNICATION PACKAGE (USB)	3856-02
TEMPERATURE PROBE	*9180 to *9183
TEMPERATURE PROBE	9472 to 9476
CLIP ON BASE	*9617
(for capacitance measurement)	
CLIP TYPE LEAD	*9618
(for capacitance measurement)	

*Note: Non-CE mark product



DIGITAL HiTESTER | 3803

Compact and basic DMM

- 4000 count display full scale
- Average rectified RMS indication type
- Optional RS-232C / USB package for transferring data captured by the 3803 to a PC



CAT III 600 V
CAT II 1000 V



OPTIONS

CARRYING CASE	3853
COMMUNICATION PACKAGE (RS-232C)	3856-01
COMMUNICATION PACKAGE (USB)	3856-02
HIGH-VOLTAGE PROBE	*9014

*Note: Non-CE mark product

DIGITAL HiTESTER

3256-50/-51 | 3257-50/-51

3256-50/-51
CAT II 1000 V
CAT III 600 V
3257-50/-51
CAT III 1000 V
CAT IV 600 V

Terminal shutter interlock mechanism



- Terminal shutter interlock mechanism exposes only the correct terminals for connection in the currently selected function
- Wide range, maximum reading 4200 digit
- High-speed response, bar graph display
- Conforms with IEC1010
- Hold-auto function automatically displays voltage or current value and resistance value

Fail-safe!
Shutter mechanism prevents incorrect test lead connection

Voltage ranges
Only V and COM terminals open
* The above photograph shows a special model with a transparent cover.

10A range
Only A and COM terminals open



Model

(Standard type) 3256-50
(3256-50 with holster) 3256-51
(Standard type) 3257-50
(3257-50 with holster) 3257-51

OPTIONS

HIGH-VOLTAGE PROBE *9014
CARRYING CASE (for 3256-51) 3853

*Note: Non-CE mark product



Check for live lines safely and easily

In the AC V range, the 3256-50 can be used to check whether power lines are live. When the sensitivity level is set to 4 and the test head is placed near a live power line, the built-in buzzer sounds and a display indicator lights. Sensitivity threshold: 100 V AC or higher

DIGITAL HiTESTER

3255-50

Tough for use on industrial power lines

- Built-in current limiter and fuse capable of withstanding 1000 V to prevent short-circuit accidents
- Wide range, maximum reading 4199 digit
- Two-terminal configuration eliminates the need for probe reconnections
- Industrial grade test leads for enhanced safety



CAT II 1000 V
CAT III 600 V

OPTIONS

TEST LEAD 9207-10
(Supplied as standard with the 3255-50)
CARRYING CASE 9371
(Supplied as standard with the 3255-50)

VOLTAGE DETECTOR | 3120 | 3480-21 | 3481-21 | 3481-22

Twin Light Audible Voltage Detector



- Green for Battery Check
- Red for Voltage Detection

SPECIFICATIONS		
Model	3480-21 (for 200V Installations)	3120 (for 100V Installations)
Measurement Function	Voltage Detection	Voltage Detection
Voltage Range	AC 90 to 600 V, 50/60 Hz	AC 70 to 600 V, 50/60 Hz
Indication	Red LED and continuous beeping sound	Red LED and continuous beeping sound
Battery Check	Green LED	Green LED
Power supply	LR44 Button alkaline batteries × 2	AAA manganese(R03) or alkaline(LR03) batteries × 2
Continuous Use	approx. 15 hours	approx. 200 hours
Dimensions, mass	20W × 126H × 15D mm, 25 g	149 mmH × φ18.5 mm, 38 g



CAT IV 600 V



LISTED
(3120)



- Bright white LED (Self battery check)
- Bright red LED and crystal audio buzzer (Voltage detection)
- Auto power off



SPECIFICATIONS

Model	3481-21 (for use on 200 to 240V lines)	3481-22 (for use on 100 to 120V lines)
Measurement Function	Voltage Detection	Voltage Detection
Voltage Range	AC 180 to 600 V, 50/60 Hz	AC 90 to 600 V, 50/60 Hz
Indication	Red Flashing LED and Beeping Buzzer	Red Flashing LED and Beeping Buzzer
Battery Check	White LED at Power ON	White LED at Power ON
Power supply	LR44 Button alkaline batteries × 3	LR44 Button alkaline batteries × 3
Continuous Use	approx. 5 hours	approx. 5 hours
Dimensions, mass	20W × 126H × 15D mm, 30g	20W × 126H × 15D mm, 30g

HIGH VOLTAGE INSULATION HiTESTER | 3455

Maximum 5kV Test Voltage - Up to 5TΩ of Insulated Resistance Testing
Safely evaluate the insulation characteristics of high voltage transformers, motors and cables

- Wide voltage range (250V to 5kV) for maximum 5TΩ of insulation resistance measurements
- Automatically calculate and display the PI (Polarization Index) and DAR (Dielectric Absorption Ratio) for all types of insulation evaluations
- Temperature compensation to accurately respond to variations in insulation material
- Internal memory stores 100 blocks of manually recorded data and 10 sets of log data
- USB interface, compact rugged case, and safe design

SPECIFICATIONS

250 V range	0.00 MΩ to 250 GΩ, Accuracy :±5 % rdg. ±5 dgt. (0 to 2.50 GΩ) ±20 % rdg. ±5 dgt. (2.50 to 250 GΩ)
500 V range	0.00 MΩ to 500 GΩ, Accuracy :±5 % rdg. ±5 dgt. (0 to 5.00 GΩ) ±20 % rdg. ±5 dgt. (5.00 to 500 GΩ)
1 kV range	0.00 MΩ to 1.00 TΩ, Accuracy :±5 % rdg. ±5 dgt. (0 to 10.0 GΩ) ±20 % rdg. ±5 dgt. (10.0 to 500 GΩ) ±30 % rdg. ±50 dgt. (500 G to 1.00 TΩ)
2.5 kV range	0.00 MΩ to 2.50 TΩ, Accuracy :±5 % rdg. ±5 dgt. (0 to 25.0 GΩ) ±20 % rdg. ±5 dgt. (25.0 to 500 GΩ) ±30 % rdg. ±50 dgt. (500 G to 2.50 TΩ)
5 kV range	0.00 MΩ to 5.00 TΩ, Accuracy :±5 % rdg. ±5 dgt. (0 to 50.0 GΩ) ±20 % rdg. ±5 dgt. (50.0 to 500 GΩ) ±30 % rdg. ±50 dgt. (500 G to 5.00 TΩ)
Functions	Insulation resistance mode: Data memory(100 data), measurement value hold, average, bar graph display, timer etc. Leak current: (1.00nA to 1.20mA), Temperature: (-10°C to 70°C) Voltage: (DC±50V to 1kV AC 50V to 750V) All measurement mode: live wire warning, battery indicators, auto power save
Interface	USB ver 2.0 (full speed)
Display	LCD with backlight
Power supply	LR6(AA) alkaline batteries × 6, 9459 BATTERY PACK 9753 AC ADAPTER
Dimensions, mass	260 W × 250.6 H × 119.5 D mm, 2.8 kg
Accessories	TEST LEAD (red, black, blue 3m) 9750-01 to 03, ALLIGATOR CLIPS (red, black, blue), LR6(AA) Alkaline batteries (6), USB CABLE(1)



OPTIONS

- | | |
|------------------------------------|---------------|
| TEST LEAD (red, black, blue 3m) | 9750-01 to 03 |
| ALLIGATOR CLIPS (red, black, blue) | 9751-01 to 03 |
| TEMPERATURE SENSOR (1m) | 9631-01 |
| TEMPERATURE SENSOR (6cm) | 9631-05 |
| TEST LEAD (red, black, blue 10m) | 9750-11 to 13 |
| BATTERY PACK | 9459 |
| AC ADAPTER | 9753 |

DIGITAL MΩ HiTESTER | 3453

For efficient insulation measurement!

- One body with four ranges: 125 V/40 MΩ, 250 V/2000 MΩ, 500 V/2000 MΩ, and 1000 V/4000 MΩ
- Accurate digital display
- Insulation measurement through sight and sound
- Memorizes on the spot (Memorizes up to 20 data points)
- Recognizes variations of resistance
- Ability to measure AC voltage and low resistance (continuity)



SPECIFICATIONS

Testing voltage	125 V DC	250 V DC	500 V DC	1000 V DC
Measurement range	4.000 MΩ or 40.00 MΩ	4.000 /40.00 /400.0 /2000 MΩ, (+ 4000 MΩ range at 1000 V mode)		
First effective measurement range	±2 % rdg. ±3 dgt. at 0.100 to 10.00 MΩ	±2 % rdg. ±3 dgt. at 0.200 to 20.00 MΩ	±2 % rdg. ±3 dgt. at 0.200 to 50.00 MΩ	±2 % rdg. ±3 dgt. at 0.200 to 999 MΩ
Second effective measurement range	±5 % rdg. at 10.01 to 40.00 MΩ	±5 % rdg. at 20.01 to 2000 MΩ	±5 % rdg. at 50.1 to 2000 MΩ	±2 % rdg. ±6 dgt. at 0 to 0.199 MΩ ±5 % rdg. at 1000 to 4000 MΩ
Voltage with no load	Not more than 1.2 times rated testing voltage			
Min. resistance measurement value (Resistance value to maintain rated voltage)	0.125 MΩ	0.250 MΩ	0.500 MΩ	2.000 MΩ
Shorting measurement current	1.2 mA max.			0.6 mA max.
Response time	Infinitude to center, infinitude to zero-MΩ within 5 second (within accuracy range)			
Low resistance (continuity)	±2 % rdg. ±8 % dgt. at 0 to 400.0Ω (aural warning below: 30Ω), Open terminal voltage: 4 V max.			
AC voltage range and accuracy	±3 % rdg. ±8 dgt. at 0 to 600 V, 50 to 60 Hz, Input resistance: 170 kΩ			

Common SPECIFICATIONS

- Discharge function** : effective
Display : Digital/4000 dgt. LCD, Bar graph/42 seg. with backlight
Functions : **Insulation resistance mode**: comparator, memory (20 data), measurement value hold, auto discharge, bar graph display (measurement switch ON: insulation resistance; measure switch OFF: voltage across measurement terminals), auto display of measurement value 1 minute after measurement start, All measurement mode: live wire warning, battery indicators, auto power save
Sampling rate : 2 times/second
Power supply : R6P(AA) ×4 or LR6(AA)×4
Dimensions : 155W×98H×80D mm, 500g
Accessories : TEST PROBE 9294(1) display cover and suspension band(1)

OPTIONS

- | | |
|-------------|-------|
| TEST PROBE | *9289 |
| BREAKER PIN | *9288 |
- *Note: Non-CE mark product

DIGITAL MΩ HiTESTER

3454-10/-11/-51

Revolutionary insulation resistance tester with continuity function all in one low price



3454-11/-51

Test voltage: 250V / 500V / 1000V DC
(3454-51: Non-CE mark product)

SPECIFICATIONS

Model	3454-10	3454-11/51
Insulation testing voltage	50 V DC / 125 V DC / 250 V DC / 500 V DC	250 V DC / 500 V DC / 1000 V DC
Measurement range	4.000/40.00/400.0/200.0 MΩ, 400.0/2000 (250V/500V range only) MΩ	4.000/40.00/400.0/500.0 MΩ, 4000 (1000V range only) MΩ
Accuracy	1st effective range: ±3 %rdg. ±4 dgt. / 2nd effective range: ±5 %rdg. ±5 dgt.	
Voltage with no load	Not more than 1.2.5 rated measurement voltage	
Short circuit current	1.2 mA max.	
Response time	∞ to center, ∞ to 0 MΩ within 5 s (within accuracy range)	
Low resistance (continuity)	Measurement range: 40.00 / 400.0 / 4.000 k / 40.00 k / 400.0 k / 4.000 MΩ Short circuit current: 200 mA Accuracy: ±3 %rdg. ±6dgt. (±5 %rdg. ±6dgt. at 400 kΩ range or higher) Open terminal voltage: 4 to 6 V Response time: 5 s max.	
AC voltage	Display indication range: 0 to 750 V Accuracy: ±3 %rdg. ±6 dgt.(up to 600V), Frequency range: 50 / 60 Hz, Input impedance: 100kΩ	

OPTIONS

- TEST PROBE 9294
- BREAKER PIN *9288
- TEST PROBE *9289
- *Alligator Clips for Model 9289
- CONNECTOR CORD 9257

*Note: Non-CE mark product

Accessories : TEST PROBE (for 3454-11/3454-10) 9294, TEST PROBE 9289. Alligator Clips (for 3454-51), Strap band (1)

- Other functions: Insulation and low resistance mode - comparator, measurement value hold; Insulation resistance mode - auto discharge;nsulation and AC voltage mode - live wire warning (when voltage of 70V ±10V exists across measurement terminals); Low resistance mode - zero adjust; All measurement modes - battery indicators, auto power save
- Display update rate: 2 times / second
- Power source: R6P manganese battery×4 or LR6 alkaline battery×4
- Dimensions and Mass: Approx. 175 W×148 H×56 D mm; Approx. 530g (with display cover closed)

MΩ HiTESTER

3451-11 to 3451-15

Compact and lightweight for perfect portability



SPECIFICATIONS

Model	3451-11	3451-12	3451-13	3451-14	3451-15
Testing voltage	125 V DC	250 V DC	500 V DC	500 V DC	1000 V DC
Rated resistance	20 MΩ	50 MΩ	100 MΩ	1000 MΩ	2000 MΩ
First effective measurement range and tolerances	±5 % of scale indication at 0.02 MΩ to 10 MΩ	±5 % of scale indication at 0.05 MΩ to 20 MΩ	±5 % of scale indication at 0.1 MΩ to 50 MΩ	±5 % of scale indication at 1 MΩ to 500 MΩ	±5 % of scale indication at 2 MΩ to 1000 MΩ
Second effective measurement range and tolerances	±10 % of scale indication at more than 10 MΩ to 20 MΩ	±10 % of scale indication at more than 20 MΩ to 50 MΩ	±10 % of scale indication at more than 50 MΩ to 100 MΩ	±10 % of scale indication at more than 500 MΩ to 1000 MΩ	±10 % of scale indication at more than 1000 MΩ to 2000 MΩ
Excepting 1st and 2nd effective measurement range include 0 MΩ & infinity indication	0.7 % of scale length	0.7 % of scale length	0.7 % of scale length	0.7 % of scale length	0.7 % of scale length
Shorting measurement current	1.2 mA max.	1.2 mA max.	1.2 mA max.	0.6 mA max.	0.6 mA max.
Scale center indication	0.5 MΩ	1 MΩ	2 MΩ	20 MΩ	50 MΩ
AC voltage scale and tolerances	±5 % f.s. at 0 to 250 V (50/60 Hz)	±5 % f.s. at 0 to 300 V (50/60 Hz)	±5 % f.s. at 0 to 500 V (50/60 Hz)	±5 % f.s. at 0 to 500 V (50/60 Hz)	±5 % f.s. at 0 to 500 V (50/60 Hz)

Common SPECIFICATIONS

- Discharge function :** effective
- Power supply :** R6P(AA)×4
- Dimensions, mass :** 152W×95H×47D mm, 420 g
- Accessories :** TEST PROBE 9292(1) CARRYING CASE 9384(1)
- Safety rating :** Conformance to IEC1010, pollution degree 2, installation category III

OPTIONS

- BREAKER PIN *9288
- PIN TYPE EARTH PROBE 9293
- *Note: Non-CE mark product

MΩ HiTESTER

3452-11 to 3452-13

Compact analog three-range insulation resistance meter



SPECIFICATIONS

Model	3452-11			3452-12			3452-13		
	25 V DC	50 V DC	100 V DC	125 V DC	250 V DC	500 V DC	250 V DC	500 V DC	1000 V DC
Testing voltage	25 V DC	50 V DC	100 V DC	125 V DC	250 V DC	500 V DC	250 V DC	500 V DC	1000 V DC
Rated resistance	10 MΩ	10 MΩ	20 MΩ	20 MΩ	50 MΩ	100 MΩ	50 MΩ	100 MΩ	2000 MΩ
First effective measurement range and tolerances	±5 % of scale indication at 0.01 MΩ to 5 MΩ			±5 % of scale indication at 0.02 MΩ to 10 MΩ			±5 % of scale indication at 0.05 MΩ to 20 MΩ		
Second effective measurement range and tolerances	±5 % of scale indication at 5 M to 10 MΩ, 0.005M to 0.01MΩ			±10 % of scale indication at 10 M to 20 MΩ, 0.01M to 0.02MΩ			±10 % of scale indication at 20 M to 50 MΩ, 0.02M to 0.05MΩ		
0MΩ & infinity indication	0.7 % of 100 V scale length			0.7 % of 500 V scale length			0.7 % of 1000 V scale length		
Open-circuit terminal voltage	Not more than 1.2 times rated testing voltage			Not more than 1.2 times rated testing voltage			Not more than 1.2 times rated testing voltage		
Rated measurement current	1 m to 1.2 mA			1 m to 1.2 mA			1 m to 1.2 mA		
Shorting measurement current	1.2 mA max.			1.2 mA max.			1.2 mA max.		
Scale center indication	0.2 MΩ	0.2 MΩ	0.5 MΩ	0.5 MΩ	1 MΩ	2 MΩ	1 MΩ	2 MΩ	50 MΩ
AC voltage scale & tolerances	±5 % f.s. at 0 to 150 V (50/60 Hz)			±5 % f.s. at 0 to 500 V (50/60 Hz)			±5 % f.s. at 0 to 500 V (50/60 Hz)		

Common SPECIFICATIONS

- Discharge function :** effective
- Power supply :** R6P(AA)×4
- Dimensions, mass :** 152W×95H×47D mm, 420g
- Accessories :** TEST PROBE 9292(1) CARRYING CASE 9384(1)
- Safety rating :** Conformance to IEC1010, pollution degree 2, installation category III

OPTIONS

- BREAKER PIN *9288
- PIN TYPE EARTH PROBE 9293
- *Note: Non-CE mark product

EARTH HiTESTER 3151

Stable measurement for earth resistance

- Measurement range for grounding resistance increased to 115 % of normal range
- Elastomer rotary knob fits the hand perfectly.
- Select the "simple" two-wire measurement method, using a low ground conductor such as the ground side of a commercial power supply, or the conventional three-wire measurement method
- Select a measurement frequency to reduce the influence of harmonics of the power supply frequency on the ground current



SPECIFICATIONS

Measurement item	Grounding resistance, Grounding voltage
Measurement ranges	10Ω (0 to 11.5Ω) to 1000Ω (0 to 1150Ω), 3 ranges 30V (0 to 30 VAC), 1 range *Using the two-wire measurement method; applied to 100Ω /1000Ω range only.
Operating method	AC phase difference
Open terminal voltage	50V AC max.
Measurement current	15mA AC max. *3mA AC max. using two-wire method.
Measurement frequency	575Hz or 600 Hz selectable
Basic accuracy	Grounding resistance: ±2.5% f.s. Grounding voltage: ±3% f.s.
Power supply	R6P (AA), 6 pieces (at least 500 operations) or LR6 (AA), 6 pieces (at least 1400 operations) *Operating time: 30 second measurement, 30 second off
Dimensions, mass	164W×119H×88D mm, 800g (main unit only)
Accessories	AUXILIARY EARTHING ROD(2) 9214, MEASURING CABLE 9215 (one earth; black 5m, yellow 10m, red 20m, 9216 CABLE WINDER: 3), CARRYING CASE 9393(1)

OPTIONS

EARTH NET (set of two) 9050

*Use in location where there is no driven-in ground and where water seepage is present

PHASE DETECTOR 3129 3129-10

Non-Metallic Contact for Optimal Safety

SPECIFICATIONS

Measurement Function	Phase detection(positive, negative), live wire check(R-S-S-T only)	
Voltage Detection Method	Electrostatic induction method	
Voltage Range	70V to 600V AC(50/60Hz)(sine wave, continuous input)(3129) 70V to 1000V(3129-10)	
Clamp Diameter	2.4 to 17mm max.(3129) 10 to 40mm(3129-10)	
Display	Phase Detection	Positive:4 LEDs lit in clockwise order and 3 short beeps Negative:4 LEDs lit in counterclockwise order and one continuous beep
	Live Wire Check	R-S and S-T lamps will light if voltage between wires are within voltage range
Battery Check Function	ON lamp blinks to indicate battery low status when instrument is turned on	
Auto Power Off	Auto shut off if no activity is detected after power is turned ON for 15 minutes	
Power Supply	Two "AA" size batteries; rated voltage:DC3.0V; maximum rated power:300mVA; continuous use:approx.70 hours(standby)	
Dimensions, Mass	70W×75H×30D mm, 200g; Cord length:0.7m (3129) 240g (3129-10)	
Accessories	Carrying case(1), strap(1), R6P manganese battery(2), spiral tube(1)	



CAT III 600 V



3129



3129-10

CAT IV 600 V

TACHO HiTESTER 3403 3404

Precise rotation speed meter



3404

3403

OPTIONS

REFLECTIVE TAPE	9211
(30 pieces/sheet, 10 sheets/1set, 12 mm × 12 mm/1 piece size)	
CONTACT ADAPTER SET	9213
(include 9032 × 2, 9033 × 2, 9212 × 1)	
METAL CONTACT TIP	9032
RUBBER CONTACT TIP	9033
PERIPHERAL RING	9212

3403: SPECIFICATIONS

Measurement ranges	r/min: rotation per minute, r/s: rotation per second r/min: (30.00 to 199.99)range to (20000 to 99990)range, 4 ranges, r/s: (0.5000 to 1.9999)range to (200.0 to 1600.0)range, 4 ranges
Sampling period	0.5 second to 2 seconds
Detection distance	Distance of 50 mm to 200 mm
Analog output	None
Power supply	R6P (AA) × 4 (continuous use of 17 hours) or AC Adapter (6 V, 300 mA, 100V only)
Dimensions, mass	62W × 180H × 38D mm, 260 g
Accessories	REFLECTIVE TAPE(1Sheet) 9211, Carrying case(1)

3404: SPECIFICATIONS

Measurement ranges	r/min: (30.00 to 199.99)range to (20000 to 99990)range, 4 ranges (at slow sampling mode) r/s: (0.5000 to 1.9999)range to (200.0 to 1600.0)range, 4 ranges (at slow sampling mode) Total: Total rotation counts from 0 to 599999 Period: Measure rotation pulses from 600μs to 2 sec.
Sampling period	Slow: 0.5 sec. to 2 sec., Fast: 0.1 sec. to 0.5 sec.
Detection distance	Distance of 50 mm to 200 mm
Analog output	1V DC at full-scale range output
Power supply	R6P (AA) × 4 (continuous use of 16 hours) or AC Adapter (6 V, 300 mA, 100V only)
Dimensions, mass	62W × 180H × 38D mm, 260 g
Accessories	REFLECTIVE TAPE (1Sheet) 9211, OUTPUT CORD 9094(1), Carrying case (1)

BATTERY HiTESTER 3554

The New Standard for Assessing Deterioration of Lead-acid Batteries

- Ideal for testing UPS batteries
- Auto Hold and Auto Memory
- Store up to 4800 sets of battery data
- Averaging function



SPECIFICATIONS

Resistance Range	3.100m/31.00 m/310.0 m/3.100 Ω
Accuracy	±0.8 %rdg.±6 dgt.; 3.000 mΩ range only: ±1.0 %rdg.±8 dgt.
Voltage Range	±6.000 V/60.00 V
Accuracy	±0.08 %rdg.±6 dgt.
Temperature Measurement Range	-10.0°C to 60.0°C (when used with 9460)
Accuracy	±1°C
Measurement Frequency	1 kHz ± 30 Hz
Measurement Current (Range)	150 mA (3 m/30 mΩ), 15 mA(300 mΩ), 1.5 mA(3 Ω); Open terminal voltage: 5 V max.
Max. Allowable Voltage	60V DC (No AC input allowed)
Comparator	Primary and secondary resistance limits, minimum voltage limit
No. of Comparator Settings	200
Data Storage	4800 sets(date & time, resistance, voltage, temperature, comparator value, judgement decision)
PC interface	USB (with bundled software for data transfer to PC)
Power Supply	AA (LR6) Alkaline Batteries × 8 for up to 10 hours of continuous use
Dimensions & Mass	192W×121H×55D mm, 790 g
Accessories	9465-10 PIN TYPE LEAD (1), USB cable (1), Application software CD (1), Carrying case (1), Strap (1), LR6 alkaline batteries (8), Replacement fuse (1), Zero adjustment board (1)

OPTIONS

CLIP TYPE LEAD Temperature Sensor	9460
PIN TYPE LEAD	9770
PIN TYPE LEAD	9771
PIN TYPE LEAD Lead	9772
REMOTE CONTROL SWITCH	9466
LARGE CLIP TYPE LEAD (non CE mark)	*9467
TIP PIN (for 9465-10)	9465-90
TIP PIN (for 9772)	9772-90
PIN TYPE LEAD (bundled with standard 3554)	9465-10

BATTERY HiTESTER 3555

Instantaneous determination of battery deterioration

- Ideal for testing compact storage batteries
- Three-rank rating of battery state: Pass, Warning, or Fail



3555: SPECIFICATIONS

Resistance Measurement	300 mΩ to 30Ω, 3 ranges, 100μΩ resolution max.
Voltage Measurement	3 or 30V DC, 2 ranges, 1 mV resolution max.
Sampling rate	1.25 times/second
Comparator functions	Setting: Upper and lower limit, for resistance, and lower limit for voltage, Output: LED, beep
Power supply	LR6(AA), 6 pieces (Continuous use of 18 hours)
Dimensions, mass	196W×130H×50D mm, 680g (including batteries)
Accessories	9461 PIN-TYPE LEAD (1), LR6 (6)

OPTIONS

LARGE CLIP TYPE LEAD	*2 9467
PIN TYPE LEAD	*1 9455
CLIP TYPE LEAD	9287-10
CARRYING CASE	9382
ZERO ADJUSTMENT BOARD(when 9461 or 9465 is used)	9454
PIN TYPE LEAD	9770
PIN TYPE LEAD	9771

*1Note: The 9455 probe is a precision instrument. Exercise appropriate care when handling it.

*2Note: Non-CE mark product

HiTESTER 3030-10

Basic tester with improved safety features

- Protected against transient voltages up to 250 V AC, preventing electric shock accidents before they can happen
- Drop proof design withstands dropping onto a concrete floor from a height of 1 meter
- LED check function
- Temperature measurement support (with optional probes)
- CE marking



SPECIFICATIONS

DC Voltage range	0.3 V (16.7 k-ohm/V), 3/12/30/120/300/600 V (20 k-ohm/V) Accuracy: ±2.5 % f.s.
AC Voltage range	12 V (9 k-ohm/V) Accuracy: ±4 % f.s. 30/120/300/600 V (9 k-ohm/V) Accuracy: ±2.5 % f.s. Average rectifier effective value
Resistance range	0 to 3 k-ohm (center scale 30 ohm), R × 1, R × 10, R × 100, R × 1 k ±3 % of scale length
DC Current range	60 μA/30 m/300 mA (150 mV internal voltage drop) Accuracy: ±3 % f.s.
Other functions	Battery check: 0.9 to 1.8 V, load resistance 10 ohm Temperature: -50 to 150 °C (9021-01 Thermister Temperature Probe is necessary, sold separately)
Safety considerations	Complies with EN61010-1:1992+A2:1995, EN61010-2-031:1994, Installation Category III (anticipated transient overvoltage 6000 V), Pollution Degree 2
Power supply	R6P(AA) × 2 batteries
Dimensions, mass	95 mm(3.74 in)W × 141 mm(5.55 in)H × 39 mm(1.54 in)D, 280 g (9.9 oz)
Accessories	TEST LEAD 9207-30 (1), fuse (1), CARRYING CASE 9390 (1)

OPTIONS

THERMISTER TEMPERATURE PROBE 9021-01 for temperature measurement
*HIGH-VOLTAGE PROBE 9017 up to 30 kV DC

*Note: Non-CE mark product

LAN CABLE HiTESTER | 3665-20

Identify the 3 most important criteria for proper networking at a glance

- Wire map check : Detect split pairs with wiring check
- Cable length : Get NVP-Enhanced measurement accuracy
- Direction check : Identify up to 21 cable destinations



SPECIFICATIONS

Measurable cable	Twisted-pair cable 100ohm characteristic impedance, shielded and unshielded, CAT 3, 4, 5, 5e and 6
Compatible connectors	RJ-45 plugs
WireMap check	Wiring condition and shielding can be confirmed using the HIOKI TERMINATOR 9690 Detectable errors: open, short, reversed, transposed, split pairs and other miswiring
Cable length check	Measurable lengths: 2 to 300 m, 6.6 to 984 ft Measurement accuracy: $\pm 4\%$ rdg. ± 1 m, $\pm 4\%$ rdg. ± 3.3 ft Display resolution: 0.1 m, 0.3ft
Direction check	Up to 21 cables can be identified using the supplied TERMINATOR 9690 and optional Models 9690-01 to 9690-04
Display	128 x 64 dot matrix LCD (with backlight)
Functions	Auto Backlight: pressing a button turns the backlight on (it turns off automatically after about 20 seconds) Beeper: sounds when pressing buttons and when measurement results are displayed Energy-Saving Mode: enter into energy-saving mode after measurement (and resume when the TEST button is pressed) Auto Power Save: the 3665-20 turns off automatically about 10 minutes after the last button press Battery Check: Battery indicator blinks when voltage falls below 2.4 V Unit Switch: Select between meters or feet
Power supply	Two AA-size (LR6) alkaline batteries 1.4VA Approx. 50 hours
Dimensions, mass	Approx. 85 W x 130 H x 33 D mm, approx. 160 g
Accessories	TERMINATOR 9690 (1) CARRYING CASE(1) (Stores the HiTESTER 3665-20 and TERMINATORS 9690)

OPTICAL POWER METER | 3661-20

LASER LIGHT SOURCE | 3662-20 | 3663-20

Test for Optical Loss in Fiber Optic Cables

3661-20 SPECIFICATIONS

Measurement functions	Optical power measurement (dBm) Measure absolute value of input optical power Optical loss measurement (dB) Automatically compare measured power with previously input reference value to calculate and display loss
Calibration wavelength	850 nm, 1310 nm, 1550 nm
Range	-60 dBm to +9 dBm (auto range)
Accuracy	± 0.22 dB ($\pm 5\%$) at -10dBm, CW, 23°C ± 5 °C
Connector	FC, SC (using optional connector adapter)
Fiber type	Single mode, multi mode (core dia. 62.5 μ m max. NA: 0.275 max.)
Light receiver	InGaAs (dia. 1 mm)
Memory	Max. 1000 data per wavelength
Power supply	LR6(AA) alkaline battery x4, 0.5 VA
Dimensions and mass	Approx. 85W x 192H (including 36 mm cover) x 35D mm, Approx. 300g (without batteries)



3662-20 (1550mm)
3663-20 (1310mm)

3661-20



3662-20, 3663-20 SPECIFICATIONS

Light-emitting element	Laser diode
Output connector	FC, SC (using optional connector adapter)
Fiber type	Single mode
Output mode	Continuous wave (CW) or modulated light (270 Hz, 1 kHz, 2 kHz)
Output wavelength	1310 \pm 20 nm (3663-20), 1550 \pm 20 nm (3662-20)
Power supply	LR6(AA) alkaline battery x2, 0.6 VA
Dimensions and mass	Approx. 76W x 159H (including 36 mm cover) x 35D mm, Approx. 180g (without batteries)

MAGNETIC FIELD HiTESTER | 3470

MAGNETIC FIELD SENSOR | 3471 | 3472

Test the magnetic field effect of home appliances against human exposure (for IEC62233, EN50366, ICNIRP1998)

3470 SPECIFICATIONS

Magnetic flux density (Band)	10 Hz to 400 kHz / 10Hz to 2 kHz / 2kHz to 400 kHz
Exposure level	General Public/Occupational
Measurement ranges	Magnetic flux density : 2.000 μ T / 20.00 μ T / 200.0 μ T / 2.000mT Exposure level : 20.00%/200.0%/2000%
Display	Indicated axis (x,y,z,R) / Magnetic flux density / Exposure level (LCD Display)
Accuracy (with a 3471 or 3472)	$\pm 3.5\%$ rdg. $\pm 0.5\%$ Ls.
Output	200 mV/f.s.(for single axis of each range) 3-axis waveform output, resultant RMS output
Interface	USB ver.1.1
Power supply	Four LR6 alkaline battery 1.5V (Battery life : Approx. 10 hours) Or 9445-02 AC Adapter, 9445-03 AC Adapter
Dimensions, mass	100 W x 150 H x 42 D mm, 870 g (batteries included)
Accessories	CD (PC application software), USB cable (1), LR6 alkaline battery (4), Carrying Case (1)

3470-01 Package:

- MAGNETIC FIELD HiTESTER 3470 x 1
- MAGNETIC FIELD SENSOR (3-axis, 100cm² sensor) 3471 x 1
- AC Adapter 9445-02 or -03 x 1

3470-02 Package:

- MAGNETIC FIELD HiTESTER 3470 x 1
- MAGNETIC FIELD SENSOR (3-axis, 100cm² sensor) 3471 x 1
- MAGNETIC FIELD SENSOR (3-axis, 3cm² sensor) 3472 x 1
- AC Adapter 9445-02 or -03 x 1
- Extension Cable 9758 x 1
- Output Cable 9759 x 1

3471 SPECIFICATIONS

Sensor cross-sectional area	100 cm ²
Rated magnetic flux density	2 mT at a single axis (There is a derating characteristics dependent on frequency)
Frequency characteristics	10 Hz to 400 kHz
Measured axes	x, y, z
External dimensions	Approx. $\phi 122 \times 295$ (L) mm
Weight	Approx. 220 g

(for IEC 62233, EN 50366)

3472 SPECIFICATIONS

Sensor cross-sectional area	3 cm ²
Rated magnetic flux density	2 mT at a single axis (There is a derating characteristics dependent on frequency)
Frequency characteristics	10 Hz to 400 kHz
Measured axes	x, y, z
External dimensions	Approx. $\phi 27 \times 165$ (L) mm
Weight	Approx. 105 g



3471



3472



3470

Options & Peripherals

METER RELAY 2103 2104

Advancing power saving and automation

- Electronic design assures high accuracy and reliability
- Ultra sensitive 1 mA, 10 mV DC movement
- Replaces relays in plug-in systems
- Includes a display lamp to illuminate movement at a glance
- Relay action delays circuit closure upon power on
- Both power circuitry and relay built-in



Standard SPECIFICATIONS

Meter class	2103: ±2.5% class, 2104: ±1.5% class
Deflecting range	Passing type, full scale
Setting pointer	Lance shape, upper limit and lower limit pointer
Setting accuracy	±1.5% of scale length
Minimum setting width	Within 3% of scale length
Relay power delay circuit	Approx. 2 second
Relay output response	Approx. 0.5 second
Output contact capacity	5A (under condition of 250V AC, 30V DC, resistance load)
Power supply	100 or 200V AC ±10%

OPTIONS

(Special specifications)

- **±1.5% class:** for Model 2103
- **Extended scale:** double or triple extended scale
- **Segmented scale:** magnified scale for up to 40 % of the maximum scale value
- **Double deflection meter:** for example, zero-centered scale
- **Relay response time:** time constant 0.05 second fixed (DC) and variable types also available
- **Setting accuracy:** Version with ±1.0 % type
- **Delay time:** Version with variable delay time after power on. 0.1 to 10 seconds: (for instruments input DC), 2 to 12 seconds: (for instruments input AC)
- **Output signal:** Version with 1 V DC /f.s. output terminal
*not isolated from input circuit ground.
- **Power supply:** Version with 110, 120, 220, 230, 240 V AC ±10 %

■ Dimensions

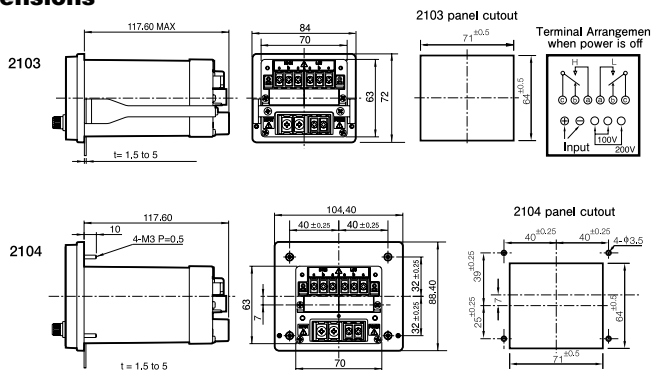

■ Standard Scale Graduations

Full-Scale Value	Graduations	Graduation Illustration
1,10,100	50	0 2 4 6 8 10
1.5,15,150	30	0 5 10 15
2,20,200	40	0 5 10 15 20
2.5,25,250	50	0 5 10 15 20 25
3,30,300	30	0 1 2 3
5,50,500	50	0 1 2 3 4 5
6,60,600	30	0 2 4 6
7.5,75,750	37.5	0 2 4 6 7.5

■ Standard Full-Scale Values

DC Ammeter		DC Voltmeter		Rectifying AC Ammeter		Rectifying AC Voltmeter	
Std. Full-Scale Value	Meter Sensitivity Spec.	Std. Full-Scale Value	Meter Sensitivity Spec.	Std. Full-Scale Value	Meter Sensitivity Spec.	Std. Full-Scale Value	Meter Sensitivity Spec.
1 μA	50mV	10 mV	100kΩ/V	200 μA	50mV	50 mV	10kΩ/V
10		15	100kΩ/V	500		100	10kΩ/V
20		30	100kΩ/V	1 mA ^{*3}		150	10kΩ/V
50		50 ^{*2}	100kΩ/V	2		300	10kΩ/V
100		100	100kΩ/V	5		500	1kΩ/V
200		150	100kΩ/V	10		1 V	1kΩ/V
500		300	100kΩ/V	20		1.5	1kΩ/V
1 mA ^{*1}		500	10kΩ/V	50		3	1kΩ/V
2		1 V	10kΩ/V	100		5	1kΩ/V
5		1.5	10kΩ/V	200		10	1kΩ/V
10	3	10kΩ/V	500	15	1kΩ/V		
20	5	10kΩ/V	1 A	30	1kΩ/V		
50	10	10kΩ/V	2	50	1kΩ/V		
100	15	10kΩ/V	3	100	1kΩ/V		
200	30	10kΩ/V	5 ^{*4}	150	1kΩ/V		
500	50	10kΩ/V		300	1kΩ/V		
1 A	100	10kΩ/V					
2	150	10kΩ/V					
5	300	10kΩ/V					
10							
20							
Full-Scale: 4-20mA	50mV	Full-Scale: 1-5V	10kΩ/V				

- When the full-scale value is larger than 20A, an external shunt device is used with the 50-mV instrument denoted by.*2
- When the full-scale value is larger than 300V, an external multiplier is used with the 1-mA instrument denoted by.*1

■ Contact operation

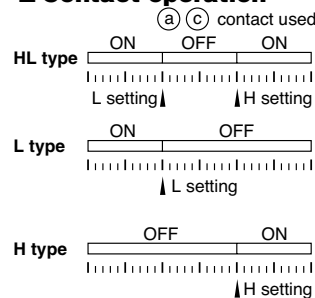

Options & Peripherals

EXTERNAL SHUNTS

HS-1 | HS-2

Used with a 50mV full scale meter

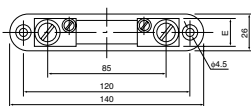

HS-1

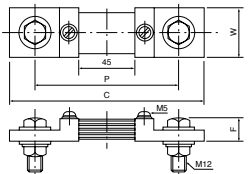

HS-2

HS-1 SPECIFICATIONS

Model & rated current	HS-1(30A), HS-1(50A), HS-1(75A), HS-1(100A), HS-1(150A), HS-1(200A), HS-1(300A)
Accuracy (50/60 Hz)	JIS-Class 0.5 (±0.5% at rated current)
Rating	50 mV
Dimensions, mass	30A type:20(E), 6(F),M4(d), M5(d) mm, 110g 50A type:20(E), 8(F),M4(d), M8(d) mm, 150g 75A type:20(E), 8(F),M4(d), M8(d) mm, 155g 100A type:20(E),15(F),M5(d), M8(d) mm, 250g 150A type:20(E),15(F),M5(d), M8(d) mm, 250g 200A type:25(E),15(F),M5(d),M10(d) mm, 320g 300A type:25(E),15(F),M5(d),M10(d) mm, 330g
Accessories	None

HS-2 SPECIFICATIONS

Model & rated current	HS-2(500A), HS-2(750A), HS-2(1000A)
Accuracy (50/60 Hz)	JIS-Class 0.5 (±0.5% at rated current)
Rating	50mV
Dimensions, mass	500A type:115(P),155(C),45(W),20(F)mm,740g 750A type:135(P),175(C),60(W),30(F)mm 1000A type:135(P),175(C),60(W),30(F)mm
Accessories	None

Note: The total resistance of the connection cord must be 0.1Ω or less.

EXTERNAL MULTIPLIER

HB-1

Used with a 1mA full scale meter

HB-1 SPECIFICATIONS

Model & rated voltage	HB-1(500V), HB-1(750V)
Accuracy (50/60 Hz)	JIS-Class 0.5 (±0.5% at rated voltage)
Rating	1mA
Dimensions, mass	See figure, 75g
Accessories	None

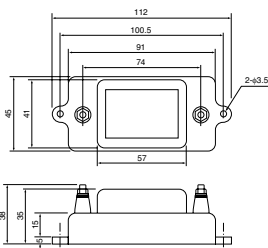

CT-2MR | CT-5MRN

CURRENT TRANSFORMER

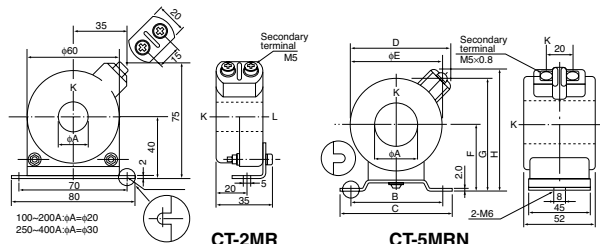

CT-2MR

CT-5MRN

CT-2MR:SPECIFICATIONS

Model & rated current	CT-2MR(100A), CT-2MR(120A), CT-2MR(150A), CT-2MR(200A), CT-2MR(250A), CT-2MR(300A)
Accuracy (50/60 Hz)	JIS-Class 1.0 (±1% of rated value)
Rated load	2VA
Secondary current	5A (all models)
Conductor voltage rating	1150VAC
Dimensions	See figure
Accessories	None

CT-5MRN:SPECIFICATIONS

Model & rated current	CT-5MRN(100A), CT-5MRN(120A), CT-5MRN(150A), CT-5MRN(200A), CT-5MRN(250A), CT-5MRN(300A), CT-5MRN(500A), CT-5MRN(600A)
Accuracy (50/60 Hz)	JIS-Class 1.0 (±1% of rated value)
Rated load	5VA
Secondary current	5A (all models)
Conductor voltage rating	1150VAC
Dimensions	100-200A:23(φA),70(B),85(C),65(D),60(φE),45(F),75(G),83(H) mm 250-300A:32(φA),70(B),85(C),76(D),70(φE),50(F),85(G),91(H) mm 500-600A:50(φA),80(B),100(C),89.5(D),85(φE),58(F),100.5(G),105(H)mm
Accessories	None

Wiring: Pass the wire through center of the C.T. When measuring under 100 A, use the equation below to find the number of times that the wire is to be passed through. Number of turns = (Primary current of C.T.)÷(Maximum value measured) However, in order to make the number of turns a full number, select the primary current or full scale.







































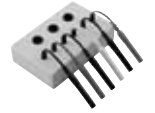
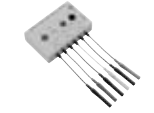

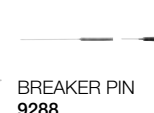

The HIOKI "Solution Factory"























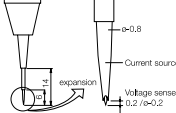











Options & Peripherals

Note: * marked products are discontinued models.

Test Leads and Probes ...Included as accessories with main unit, or sold separately (optional products)

						
TEST LEAD 3851-10 ... for 3251*, 3252*, 3253* ... 3801-50, 3802-50, 3803 ... 3804-50, 3805-50, 7016	HIGH VOLTAGE PROBE 9014 for 3250s	HIGH VOLTAGE PROBE 9017 for 3030-10	THERMISTER TEMPERATURE PROBE 9021-01 for 3030-10, 3127-10, 3128-10	TEST LEAD 9060 for 3008	TEST LEAD 9060-01 for 3008	TEST LEAD 9067 ... for 3127-10, 3128-10
						
OUTPUT CORD 9094 for 3412-50, 3283 3284, 3285, 3290 3290-10 3404	4-TERMINAL PROBE 9140 for 3504, 3504-10 ... 3505, 3506, 3511-50, 3522-50, 3532-50	PINCHER PROBE 9143 for 3504, 3504-10 ... 3505, 3506, 3511-50, 3522-50, 3532-50	CONNECTION CORD 9165 for 7075	CONNECTION CORD 9166 for 7075	INPUT CORD 9168 for 7011	TEST LEAD 9170-10 for 3156, 7011
						
ENCLOSURE PROBE 9195 for 3156	CONNECTION CORD 9197 ... for MEMORY HiCORDER	CONNECTION CORD 9198 ... for MEMORY HiCORDER	CONVERSION ADAPTOR 9199 ... for MEMORY HiCORDER	TEST LEAD 9207-30 for 3030-10	TEST LEAD 9207-10 for 3281, 3282, 3284, 3285 3256-50l-51, 3257-50l-51	TEST LEADS 9208 for 3280-10 ... 3280-20, 3287, 3288
						
TEST LEADS HOLDER 9209 for 3280-10 ... 3280-20, 3287, 3288	MEASURING CABLE 9215 for 3151	CONNECTION CORD 9217 ... for MEMORY HiCORDER	CONNECTION CABLE 9219 ... for 9695-02, 9695-03	CONNECTION CORD 9257 ... for 8205-10, 8206-10 ... 3454-11, 3454-10, 3453 3118-11, 3118-12	TEST FIXTURE 9261 for 3503, 3511-50 ... 3520*, 3521*, 3522-50 ... 3530*, 3531*, 3532-50	TEST FIXTURE 9262 for 3511-50 3522-50, 3532-50
						
THERMISTER TEMPERATURE PROBE 9263 for 3511-50, 3522-50 3532-50	WIRING ADAPTER 9264-01 for 3196	WIRING ADAPTER 9264-02 for 3196	DC BIAS VOLTAGE UNIT 9268 for 3511-50 3522-50, 3532-50	DC BIAS CURRENT UNIT 9269 for 3511-50 3522-50, 3532-50	CLIP TYPE LEAD 9287-10 for 3239, 3540 3541, 3555 3560, 3561	BREAKER PIN 9288 ... for 3118-11, 3118-12, 3451-11, 3451-12, 3451-13, 3451-14, 3451-15, 3452-11, 3452-12, 3452-13, 3453, 3454s
						
TEST PROBE 9289 ... for 3118-11, 3118-12 ... 3154, 3453, 3454s	TEST PROBE 9292 ... for 3451-11, 3451-12 3451-13, 3451-14 3451-15, 3452-11 3452-12	PIN TYPE EARTH PROBE 9293 ... for 3451-11, 3451-12 3451-13, 3451-14 3451-15, 3452-11 3452-12	TEST PROBE 9294 ... for 3117s*, 3118-11 ... 3118-12, 3154, 3453	CURRENT PROBE 9296 for 3157, 3157-01	CURRENT APPLY PROBE 9297 for 3157, 3157-01	SWITCHED PROBE 9299 for 3154

Note: * marked products are discontinued models.

						
CONNECTION CABLE 9300 for 3541	CONVERSION CABLE 9318 for 8940 (9270-71/72/77/78/79)	CONVERSION CABLE 9319 for 8940 (3273,3273-50)	CONVERSION CABLE 9323 for 8807/8808 (9320/9321)	POWER CORD 9324 for 9322 (LOGIC INPUT)	POWER CORD 9325 for 9322(8940)	CONNECTION CORD 9326 for 8205*, 8205-10
						
POWER CORD 9328 .. for 9322(8950/8953)	VOLTAGE CORD 9438-02 for 3196	VOLTAGE CORD 9438-03 for 3199 9438-05 for 3197	CLIP TYPE LEAD 9452 for 3239, 3540 3541, 3555 3560, 3561	FOUR TERMINAL LEAD 9453 for 3239, 3540 3541, 3555 3560, 3561	ZERO ADJUSTMENT BOARD 9454 for 3239, 3540 3541, 3554 3555, 3560, 3561	PIN TYPE LEAD 9455 for 3239, 3540 3541, 3555 3560, 3561
						
CLIP TYPE LEAD WITH TEMPERATURE SENSOR 9460 for 3540, 3554	PIN TYPE LEAD 9461 .. for 3239, 3540, 3541 3555, 3560, 3561	PIN TYPE LEAD 9465 .. for 3239, 3540, 3541 3555, 3560, 3561	PIN TYPE LEAD 9465-10 .. for 3239, 3540, 3541 3554, 3555 3560, 3561	REMOTE CONTROL SWITCH 9466 ... for 3554, 3560, 3561	LARGE CLIP TYPE LEAD 9467 for 3239, 3540 3541, 3554 3560, 3561	H.V. TEST LEAD 9615 .. for 3153, 3158, 3159 3173, 3930
						
CLIP ON BASE 9617 for 3501 3801-50, 3802-50 3804-50, 3805-50	CLIP-TYPE LEAD 9618 for 3501 3801-50, 3802-50 3804-50, 3805-50	VOLTAGE CORD 9635 for 3286-20	VOLTAGE CORD 9635-01 for 3286-20	CONNECTION CABLE 9639 ... for 3637-20, 3645-20	CONNECTION CABLE 9641 ... for 8420-51, 8421-51 8422-51	10:1 PROBE 9665 .. for MEMORY HiCORDER
						
100:1 PROBE 9666 .. for MEMORY HiCORDER	SMD TEST FIXTURE 9677 ... for 3511-50, 3522-50 3532-50, 3535	SMD TEST FIXTURE 9699 ... for 3511-50, 3522-50 3532-50, 3535	PIN TYPE LEAD 9770 .. for 3239, 3540, 3541, 3555, 3560, 3561	PIN TYPE LEAD 9771 .. for 3239, 3540, 3541, 3555, 3560, 3561	PIN TYPE LEAD 9772 .. for 3239, 3540, 3541 3554, 3555 3560, 3561	ALLIGATOR CLIPS (used with Test Lead, insert), for 9170, or similar devices

Options & Peripherals

ELECTRODE and SHIELDING BOX (for SM-8200 Series, DSM-8104, DSM8542 options)

ELECTRODE FOR CHIP CAPACITOR SME-8360



The electrodes on this fixture are for insulation resistance measurement of chip capacitors, and the fixture can be adjusted anywhere from 0 to 11 mm to measure a wide range of chip capacitors. When the fixture is connected with the interlock connection cable, measurement voltage is disabled when the lid is open. Plugs need to be modified when used in combination with the SM-8200 series.

External Dimensions: Approx. 200 (W) × 52 (H) × 150 (D) mm, Lead Length: Approx. 85 cm, connects with special Hioki plug.

PLATE SAMPLE ELECTRODE SME-8310



The electrodes on this fixture are for measuring the characteristic resistivity of flat samples up to 100 mm square and 8 mm thick: the main electrode is 50 mm in diameter, and the guard electrode has 70 mm ID and 80 mm OD. When the fixture is connected with the interlock connection cable, measurement voltage is disabled when the lid is open. A side panel switch easily selects between volume and surface resistivity.

External Dimensions: Approx. 215 (W) × 78 (H) × 165 (D) mm, Lead Length: Approx. 75 cm, connects with special Hioki plug.

ELECTRODE FOR FLAT SAMPLE SME-8311



The electrodes on this fixture are for measuring characteristic resistivity of flat samples up to 40 × 100 mm and 8 mm thick. The main electrode is 19.6 mm in diameter, and the guard electrode has 24.1 mm ID and 28.8 mm OD. A side panel switch easily selects between volume and surface resistivity.

External Dimensions: Approx. 215 (W) × 78 (H) × 165 (D) mm, Lead Length: Approx. 75 cm, connects with special Hioki plug.

WEIGHT ELECTRODE SME-8320



These electrodes for flat samples are used in combination with the SME-8350 Shielded Enclosure. Easily measures surface and volume resistivity of even coarse surfaces such as carpet. The main electrode is 50 mm in diameter, and the guard electrode has 70 mm ID and 80 mm OD. The jig for concentric electrodes is included.

Accessories: Two banana-plug leads

Note: Illustrated with the SM-8350 shielded enclosure.

ELECTRODE FOR SURFACE RESISTANCE SME-8302



This two-electrode probe is suitable for surface resistivity measurement of curved surfaces such as molded resin and rubber products, and for small samples. Measures surface resistivity simply by pressing the probe tips on the sample. Electrode spacing is 10 mm, and measures up to $10^{10}\Omega$. (4 mm inter-electrode spacing)

External Dimensions: Approx. 40 mm OD × 115 mm long, Lead Length: Approx. 1 m, connects with special Hioki plug.

SURFACE RESISTANCE MEASUREMENT ELECTRODE SME-8301



Measures surface resistivity simply by pressing the probe tips on the sample. Primarily intended for use with the SM-8213, to measure surface resistivity of electrostatic-discharge-related samples. Measures up to $10^{10}\Omega$.

External Dimensions: Approx. 60 OD × 50 mm long, Lead Length: Approx. 1 m, connects with special Hioki plug.

LIQUID SAMPLE ELECTRODE SME-8330



The electrodes for fluid samples are equipped with a guard. Capacity is 25 mL, capacitance between main and counter electrodes is approximately 45 pF, electrode constant is about 500 cm inter-electrode spacing is 1 mm, electrode OD is 36 mm and height is about 140 mm. Measures up to $10^{19}\Omega\text{cm}$ (@1,000 V) when combined with the SM-8220.

Accessories: Connection cable, one each red and black, approx. 60 cm long

CONTINUOUS LIQUID SAMPLE ELECTRODE SME-8335



The insulation resistance of fluids such as machine oil or irrigation fluid can be measured in the flowing state through 1/4-inch NPT joints. The cell can be mounted with U-bolts using the supplied metal accessory. Container volume is about 30 mL, and electrode constant is about 75 cm.

External Dimensions: Approx. 58 OD × 80 mm height, Lead Length: Approx. 5 m, with special Hioki plug.

SHIELDING BOX SME-8350



This enclosure provides electromagnetic shielding when measuring samples with high insulation resistance or reactivity. When used with the SME-8320 Weight Electrodes, it provides the counter or guard electrode. When measuring electronic components such as capacitors and transformers, it shields against external noise and leakage current to provide stable measurements.

External Dimensions: Approx. 250 (W) × 100 (H) × 200 (D) mm, Lead Length: Approx. 80 cm, with special Hioki plug.

STANDARD RESISTOR SR-2



This resistance box is designed for calibrating Hioki's series of ultra insulation testers. The construction ensures secure connection between the box and the tester. Maximum operating voltage is 1,000 V DC, and it provides 24 resistance values between 10 M Ω and 10,000 M Ω .

External Dimensions: Approx. 270 (W) × 90 (H) × 195 (D) mm

RECORDING PAPERS ...Sold separately (optional products)

Model	Recording Paper	Paper Size
LEAK CURRENT HITESTER 3155-01*	9233	58 mm × 10 m, 10 rolls
CLAMP ON POWER HITESTER 3165*	9223	58 mm × 10 m, 10 rolls
POWER HITESTER 3193	9232	74 mm × 10 m, 10 rolls
MOTOR/HARMONIC HITESTER 3194	9232	74 mm × 10 m, 10 rolls
POWER QUALITY ANALYZER 3196	9237	80 mm × 25 m, 4 rolls
RESISTANCE HITESTER 3541	9237	80 mm × 25 m, 4 rolls
MICRO HICORDER 8205-10	9235 9236-01	60 mm × 15 m, 10 rolls 60 mm × 15 m, climate-resistant, 10 rolls
MICRO HICORDER 8206-10	9235 9236-01	60 mm × 15 m, 10 rolls 60 mm × 15 m, climate-resistant, 10 rolls
MEMORY HILOGGER 8420-01*	9234	112 mm × 18 m, 10 rolls
MEMORY HILOGGER 8420-51	9234	112 mm × 18 m, 10 rolls
MEMORY HILOGGER 8421-01*	9234	112 mm × 18 m, 10 rolls
MEMORY HILOGGER 8421-51	9234	112 mm × 18 m, 10 rolls
MEMORY HILOGGER 8422-01*	9234	112 mm × 18 m, 10 rolls
MEMORY HILOGGER 8422-51	9234	112 mm × 18 m, 10 rolls
POWER HICORDER 8715-01	9234	112 mm × 18 m, 10 rolls
MEMORY HICORDER 8807-01	9234	112 mm × 18 m, 10 rolls

Model	Recording Paper	Paper Size
MEMORY HICORDER 8807-51	9234	112 mm × 18 m, 10 rolls
MEMORY HICORDER 8808-01	9234	112 mm × 18 m, 10 rolls
MEMORY HICORDER 8808-51	9234	112 mm × 18 m, 10 rolls
MEMORY HICORDER 8826	9229 9229-01	264 mm × 30 m, 6 rolls 264 mm × 30 m, perforated, 6 rolls
MEMORY HICORDER 8835-01	9221	110 mm × 30 m, 10 rolls
MEMORY HICORDER 8841	9231	216 mm × 30 m, 6 rolls
MEMORY HICORDER 8842	9231	216 mm × 30 m, 6 rolls
MEMORY HICORDER 8852, 8852-01*	9221	110 mm × 30 m, 10 rolls
MEMORY HICORDER 8855	9231	216 mm × 30 m, 6 rolls
MEMORY HICORDER 8860-50, 8861-50	9231	216 mm × 30 m, 6 rolls
PRINTER UNIT 8992	9234	112 mm × 18 m, 10 rolls
PRINTER UNIT 8994	9231	216 mm × 30 m, 6 rolls
DIGITAL PRINTER 9203	9233	58 mm × 10 m, 10 rolls
PRINTER 9442	1196	112 mm × 25 m, 10 rolls
PRINTER UNIT 9604	9232	74 mm × 10 m, 10 rolls
PRINTER 9670	9237	80 mm × 25 m, 4 rolls

Temperature probes or sensors ...Included as accessories with main unit, or sold separately (optional products)

Model	Type/Note	Compatible Instrument
THERMISTER TEMPERATURE PROBE 9021-01	-50 to 200°C	3030-10, 3127-10, 3128-10
TEMPERATURE PROBE 9180	Sheath type, up to 750°C non-waterproof	3412-50, 3441, 3442
TEMPERATURE PROBE 9181	Surface type, up to 400°C non-waterproof	3412-50, 3441, 3442
TEMPERATURE PROBE 9182	Sheath type, up to 750°C non-waterproof	3412-50, 3441, 3442
TEMPERATURE PROBE 9183	Sheath type, up to 750°C non-waterproof	3412-50, 3441, 3442
RJ SENSOR 9184	reference contact compensation -25 to 80°C	7011
TEMPERATURE PROBE 9188	included with the 3227	3227*
TEMPERATURE PROBE 9451	included with the 3540	3540
THERMISTER TEMPERATURE PROBE 9462	-50 to 150°C	3281, 3282
TEMPERATURE HUMIDITY SENSOR 9463	fixed type	3625
TEMPERATURE HUMIDITY SENSOR 9464	extension type, (2.7m)	3625
TEMPERATURE PROBE 9472	Sheath type, up to 300°C waterproof structure	3441, 3442
TEMPERATURE PROBE 9472-50	Sheath type, up to 300°C waterproof structure	3446-01
TEMPERATURE PROBE 9473	Sheath type, up to 800°C waterproof structure	3441, 3442
TEMPERATURE PROBE 9473-50	Sheath type, up to 800°C waterproof structure	3446-01
TEMPERATURE PROBE 9474	Sheath type, up to 300°C waterproof structure	3441, 3442
TEMPERATURE PROBE 9475	Sheath type, up to 500°C waterproof structure	3441, 3442

Model	Type/Note	Compatible Instrument
TEMPERATURE PROBE 9476	Surface type, up to 500°C non-waterproof	3441, 3442
TEMPERATURE PROBE 9476-50	Surface type, up to 500°C non-waterproof	3446-01
TEMPERATURE PROBE 9478	Sheath type, up to 300°C Waterproof structure	3447-01(Pt-100)
TEMPERATURE PROBE 9479	Sheath type, up to 300°C Waterproof structure	3447-01(Pt-100)
HUMIDITY SENSOR 9680	1 m length	3641-20
HUMIDITY SENSOR 9680-01	5 m length	3641-20
HUMIDITY SENSOR 9680-02	10 m length	3641-20
TEMPERATURE SENSOR 9631-01	1 m length	3632/3633/3641-20
TEMPERATURE SENSOR 9631-11	5 m length	3632/3633/3641-20
TEMPERATURE SENSOR 9631-21	10 m length	3632/3633/3641-20
TEMPERATURE SENSOR 9631-02	1 m length	3632/3633/3641-20
TEMPERATURE SENSOR 9631-03	1 m length	3632/3633/3641-20
TEMPERATURE SENSOR 9631-04	1 m length	3632/3633/3641-20
TEMPERATURE SENSOR 9631-14	5 m length	3632/3633/3641-20
TEMPERATURE SENSOR 9631-24	10 m length	3632/3633/3641-20
TEMPERATURE SENSOR 9631-05	30 mm length	3632/3633/3641-20

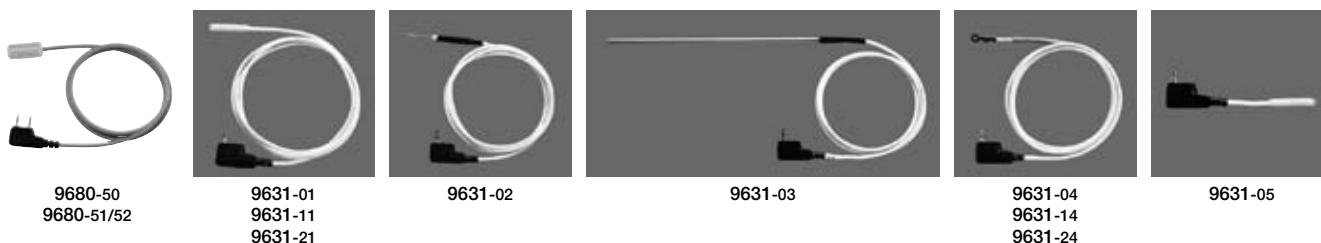
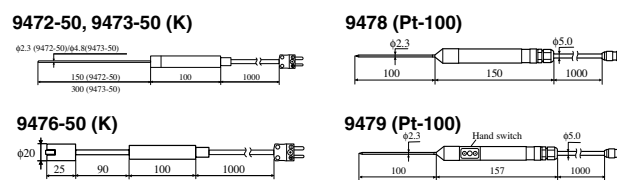
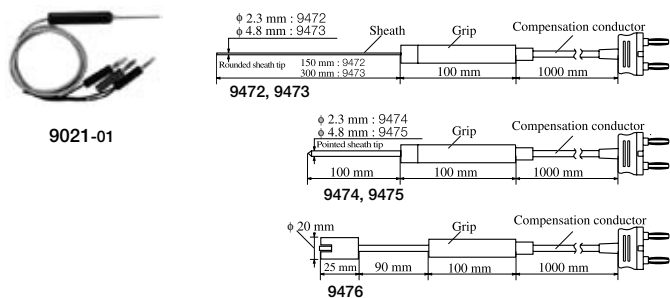

Options & Peripherals

Note: * marked products are discontinued models.

All Accessories

RECORDING PAPER **1196**
..... for 3154, 3332-02, 3511, 3196 (10rolls)
TEST LEAD **3851-10**
..... for 3801, 3802, 3803, 3804, 3805
RS-232C PACKAGE **3852** for 3801, 3802
CARRYING CASE **3853** for 3803, 3804, 3805
RS-232C PACKAGE **3854** for 3803, 3804, 3805
COMMUNICATION PACK (RS-232C) **3856-01**
.. for 3801-50, 3802-50, 3803, 3804-50, 3805-50, 7016
COMMUNICATION PACK (UUB) **3856-02**
.. for 3801-50, 3802-50, 3803, 3804-50, 3805-50, 7016
USB PACKAGE **3856-02**
..... for 3801-50, 3802-50, 7016
INTERFACE PACK **3909** for 3443, 3444, 3445
CLAMP ON PROBE **9010** for 8200*, 3255
CLAMP ON PROBE **9010-50** for 8714*, 8715
HIGH VOLTAGE PROBE **9014**
..... for 3081*, 3205*, 3207*, 3208*, 3209*, 3212*, 3230*, 3250S
HIGH VOLTAGE PROBE **9017**
..... for 3000*, 3012*, 3015*, 3021*, 3030
CLAMP ON PROBE **9018**
..... for 8205, 8206, 8805*, 8807, 8808
CLAMP ON PROBE **9018-50** for 8714*, 8715
THERMISTER TEMPERATURE PROBE **9021-01**
.. for 3000*, 3007*, 3015*, 3021*, 3030, -12, 3100*, 3127-11
METAL CONTACT TIP **9032** 3402*, 3403, 3404
RUBBER CONTACT TIP **9033**
..... for 3402*, 3403, 3404
AC ADAPTER **9035**
.. for 3108*, 31*, 32*, 61*, 62*, 3220*, 05*, 09*, 3402-04, 22 (6V)*
AC ADAPTER **9036**
..... for 3110*, 3204*, 9005*, 9006*, 3411 (9V)*
AC ADAPTER **9039** for 3501 (12V)
EARTH NETS **9050** for 3124*, 3150*, 3151
TEST LEAD **9060** for 3008, 3125*
TEST LEAD **9060-01** for 3108*, 3109*
TEST LEAD **9067**
..... for 3261*, 3262*, 3127-10, 3128-10
AC ADAPTER **9070** for 3118, 3119*
RECORDING PAPER **9073**
..... for 8201*, 8202*, 8204 (10rolls)*
RECORDING PAPER **9074**
..... for 8203 (1ch) (10rolls)*
EXTERNAL SHUNT **9081** for 3245 (10A)*
CARRYING CASE **9083**
..... for 3108*, 3109*, 3131*, 3132*
CARRYING CASE **9084**
..... for 3180*, 3222*, 3223*, 3235*
CARRYING CASE **9088** for 3030*, 3021*
OUTPUT CORD **9094**
..... for 3154, 3225*, 3403, 04, 3412-50, 3422*, 3283, 84, 85
CLAMP ON PROBE **9132** for AC1000A
CLAMP ON PROBE **9132-10** for 8714*, 8715
RECORDING PAPER **9135** for 3215 (5rolls)*
4-TERMINAL PROBE **9140**
..... for 3511, 3520*, 3521*, 3522, 3532
PINCHER PROBE **9143**
..... for 3511, 3520*, 3521*, 3530*, 3522, 3532
CARRYING CASE **9144** for 3030*, 3021*
CARRYING CASE **9148**
..... for 3128, 3261*, 3262*, 3263*
GP-IB CONNECTOR CABLE **9151-02**
..... for 3511, 3330-02*, 3332 (2m)
GP-IB CONNECTOR CABLE **9151-04**
..... for 3511, 3330-02*, 3332 (4m)
TEST LEADS WITH FUSE **9153**
..... for 3030, 3127*, 3128*, 3127-11
CONNECTION CORD **9165**
..... for 3511, 3601*, 7075, 7075-01(BNC-BNC)
CONNECTION CORD **9166**
..... for 3511, 3601*, 7075, 7075-01 (BNC-Clip)
INPUT CORD **9168** for 7010*, 7011
TEST LEAD **9170** for 3156, 3237*, 7011
INPUT CORD **9177** .. for 8904*, 8906*, 8932*, 9555
SHEATH TYPE TEMPERATURE PROBE **9180**
..... for 3412-50, 3441/42 (200°C)
SURFACE TEMPERATURE PROBE **9181**
..... for 3412-50, 3441/42 (400°C)
SHEATH TYPE TEMPERATURE PROBE **9182**
..... for 3412-50, 3441/42 (1000°C)
SHEATH TYPE TEMPERATURE PROBE **9183**
..... for 3412-50, 3441/42 (800°C)
TEMPERATURE PROBE **9184**
..... for 7010*, 7011 (-25°C~80°C)
TEST LEAD **9185** for 3154, 3255
INPUT CORD **9186** for 8851(10:1)*
TEMPERATURE PROBE **9188** for 3227*
APPLY UNIT **9196** for 3155*

CONNECTION CORD **9197**
..... for MEMORY HiCORDER
CONNECTION CORD **9198**
..... for MEMORY HiCORDER
CONVERSION ADAPTER **9199**
..... for MEMORY HiCORDER
DIGITAL PRINTER **9203**
..... for 3227*, 3540, 3550, 3560
TEST LEAD **9207** for 3030, 3282-01, 3284, 3285
TEST LEAD **9207-10**
..... for 3281, 82, 84, 85, 3256-50/-51, 3257-50/-51
TEST LEADS **9207-30**
..... for 3030-10, 3127-10, 3128-10
TEST LEADS **9208**
..... for 3287, 3280, -01, -10, -11, 3288
TEST LEADS HOLDER **9209**
..... for 3287, 3280, -01, -10, -11, 3288
REFLECTIVE TAPE **9211** for 3402*, 3403, 3404
PERIPHERAL RING **9212** for 3402*, 3403, 3404
CONTACT ADAPTER **9213** for 3403, 3404
AUXILIARY EARTHING ROD **9214** for 3151
MEASURING CABLE **9215** for 3151
CABLE WINDER **9216** for 3151
CONNECTION CORD **9217**
..... for MEMORY HiCORDER
CONNECTION CABLE **9219**
..... for 3169, 3196, 9695-02, 9695-03
RECORDING PAPER **9221**
..... for 8801*, 8802*, 8835-01 (110mm × 30m 10rolls)
RECORDING PAPER **9222**
..... for 3224-02*, 3225-02*, 3235*
..... 9200 (38mm × 8.5m 5rolls)
RECORDING PAPER **9223**
..... for 3165*, 3191 (80mm × 30m 5rolls)*
RECORDING PAPER **9224**
..... for 8820 (216mm × 50m 6rolls)*
RECORDING PAPER **9226**
..... for 8601 (24mm × 15m 10rolls)*
RECORDING PAPER **9227**
..... for 3234 (38mm × 3m 5rolls)*
RECORDING PAPER **9228**
..... for 8850 (114mm × 30m 10rolls)*
RECORDING PAPER **9229**
..... for 8825 (264mm × 30m 6rolls)*
RECORDING PAPER(PERFORATED) **9229-01**
..... for 8826 (264mm × 30m 6rolls)
RECORDING PAPER **9231**
..... for 8840*, 8841, 8842 (216mm × 30m 6rolls), 8855, 8860
RECORDING PAPER **9232**
..... for 8804*, 8205, 8206, 8806*
..... 3193 (74mm × 10m 10rolls)
RECORDING PAPER **9233** for 9203, 9203-01
RECORDING PAPER **9234** for 8807, 8808, 8420
RECORDING PAPER **9235** for 8205, 8206
RECORDING PAPER **9236-01** for 8205, 8206
RECORDING PAPER **9237** for 9670 (3196)
CARRYING CASE **9245** for 3286-20
CARRYING CASE **9246** for 3664, 9742
CONNECTION CORD **9257** .. for 8205, 8206, 8220*
TEST FIXTURE **9261** for LCR
TEST FIXTURE **9262** for LCR
THERMISTER TEMPERATURE PROBE **9263**
..... for 3511, 3522, 3532
WIRING ADAPTER **9264-01** for 3196, (3P3Ø)
WIRING ADAPTER **9264-02** for 3196, (3P4Ø)
MEASUREMENT CABLE **9265** for 3143
SAFETY TEST DATA MANAGEMENT SOFTWARE **9267**
..... for 3153, 3156/57/58/59, 3332
DC BIAS VOLTAGE UNIT **9268**
..... for 3511, 3522, 3532
DC BIAS CURRENT UNIT **9269**
..... for 3511, 3522, 3532
CLAMP ON SENSOR **9270**
..... for 3191*, 3165*, 3192*, 3167* (20A)
CLAMP ON SENSOR **9271**
..... for 3191*, 3165*, 3192*, 3167* (200A)
CLAMP ON SENSOR **9272-10**
..... for 3191*, 3165*, 3192*, 3167* (20/200A)
CLAMP ON AC/DC SENSOR **9274**
..... for AC/DC20A
CLAMP ON AC/DC SENSOR **9276**
..... for AC/DC150A
UNIVERSAL CLAMP ON CT **9277**
..... for 3192*, 3193, 3167* (AC/DC20A)
UNIVERSAL CLAMP ON CT **9278**
..... for 3192*, 3193, 3167* (AC/DC200A)
UNIVERSAL CLAMP ON CT **9279**
..... for 3192*, 3193, 3167* (AC/DC 500A)

CLIP TYPE LEAD **9287-10** for 3540, 3541, 3560
BREAKER PIN **9288** for 3451, 52, 53, 54
TEST PROBE **9289** for 3154, 3454-51
CLAMP ON ADAPTER **9290-10**
..... for 1000A CT 10 : 1
CLAMP ON SENSOR **9291** for 3166*
TEST PROBE **9292** for 3451, 3452
PIN TYPE EARTH PROBE **9293** for 3451, 3452
TEST PROBE **9294** for 3154, 3453
CURRENT PROBE **9296** for 3157, 3157-01
CURRENT APPLY PROBE **9297**
..... for 3157, 3157-01
SWITCHED PROBE **9299** for 3154
CONNECTION CABLE **9300** for 3541
PT **9303**
..... for 8815*, 25*, 30*, 32*, 51* (PT 40:1,20:1)
TRIGGER CORD **9305**
..... for 8801*, 8802*, 8803*, 8820*, 8835-01
LOGIC PROBE **9315** for 8852*
CONVERSION CABLE **9318** for 8940
CONVERSION CABLE **9319** for 8940
LOGIC PROBE **9320** for MEMORY HiCORDER
LOGIC PROBE **9320-01** for 8807, 8808
LOGIC PROBE **9321** for MEMORY HiCORDER
LOGIC PROBE **9321-01** for 8807, 8808
DIFFERENTIAL PROBE **9322**
..... for MEMORY HiCORDER
CONVERSION CABLE **9323** for 9320, 9321
POWER CORD **9324** for 9322
POWER CORD **9325** for 8940, 9322
CONNECTION CORD **9326** for 8205, 8206
LOGIC PROBE **9327** for MEMORY HiCORDER
POWER CORD **9328** for 8855
TERMINAL UNIT **9329**
..... for 8420-51, 8421-51, 8422-51
WAVE PROCESSOR **9330-01** for 8835
WAVE PROCESSOR **9331-01** for 8806*
WAVE COMMUNICATOR **9332** for 8808
LAN COMMUNICATOR **9333**
..... for MEMORY HiCORDER
LOGGER COMMUNICATOR **9334** for 8420
WAVE PROCESSOR **9335**
..... for MEMORY HiCORDER
WIREMAP TERMINATOR **9336** for 3660
DIRECTION TERMINATOR **9337** for 3660
CARRYING CASE **9338** for 3143
CARRYING CASE **9339** for 3196 (soft case)
CARRYING CASE **9340** for 3196 (hard case)
CARRYING CASE **9344** for 8205, 8206
CARRYING CASE **9345** for 3285
CARRYING CASE **9347** for 8220*
CARRYING CASE **9349** for 8842
CARRYING CASE **9350** for 3660
CARRYING CASE **9351** .. for 3127*, 3127-11, 3100*
CARRYING CASE **9355** .. for 3265*, 3267*, 3286
CARRYING CASE **9359** for 3117*
CARRYING CASE **9360** .. for 3165* (9270~9272)
CARRYING CASE **9363** for 3118-11
CARRYING CASE **9364** for 3118-12
CARRYING CASE **9371** for 3255
CARRYING CASE **9372** for 8804*, 8806*
CARRYING CASE **9375** for 9277~9279
CARRYING CASE **9376** for 3423
CARRYING CASE **9377** for 3551
CARRYING CASE **9378** for 3256
CARRYING CASE **9380** for 7011
CARRYING CASE **9382** for 3550, 3555
CARRYING CASE **9384** for 3452
CARRYING CASE **9386**
..... for 3441, -01, -02, 3442-02, -03
CARRYING CASE **9386-01**
..... for 3441, 3442, 3446, 3447
CARRYING CASE **9388** .. for 8835*, 8835-01, 3155*
CARRYING CASE **9390** for 3030-10, 3030-12
CARRYING CASE **9391** for 8807, 8808, 8420
CARRYING CASE **9392** for 3625*
CARRYING CASE **9393** for 3151
CARRYING CASE **9397-01** .. for 8855, 8841, 8720*
CARRYING CASE **9398**
..... for 3280, -01*, -10, -11, 3287, 3288
CARRYING CASE **9399**
..... for 3281, 3282, 3284, 3282-01
CARRYING CASE **9400** for 3290
AC ADAPTER **9418-10** for 3167, 3551, 7011
AC ADAPTER **9418-15**
..... for 3197, 8420/21/22, 8714*/15, 8807/08
BATTERY PACK **9420** for 7011, 8804*
CONNECTION CABLE **9425**

*Note: * marked products are discontinued models.*

..... for 9203, 9203-01
 DC POWER ADAPTER **9433** for 8841, 8842, 8720*
 CONNECTION CABLE **9436** for 3423*
 CONNECTION CABLE **9437** for 8927(8845)*
 VOLTAGE CORD **9438** for 3166*
 VOLTAGE CORD **9438-02** for 3196
 VOLTAGE CORD **9438-03, -05** for 3169, 3197
 DC POWER ADAPTER **9439** for 8835
 CONNECTION CABLE **9440** for 3166*, 3169-01
 CONNECTION CABLE **9441** for 3166*, 3169-01
 PRINTER **9442** for 3443, 44
 AC ADAPTER **9443-02** for 3166*, 3330-02*, 3332, 3511, 3154
 AC ADAPTER **9443-03** for 3166*, 3330-02*, 3332, 3511, 3154
 CONNECTION CABLE **9444** for 3166*, 3196, 3332, 9442, 3511
 AC ADAPTER **9445-02** for USA, CANADA
 AC ADAPTER **9445-03** for EU
 CONNECTION CABLE **9446** for 3522, 3532, 3330*
 BATTERY PACK **9447** for 8807, 8808, 8420
 TEMPERATURE PROBE **9451** for 3540
 CLIP TYPE LEAD **9452** for 3560, 3540
 FOUR TERMINAL LEAD **9453** for 3560, 3540
 ZERO ADJUSTMENT BOARD **9454** for 3551, 3560
 PIN TYPE LEAD **9455** for 3226*, 3227*, 3540, 3560
 AC ADAPTER **9458** for 3196
 BATTERY PACK **9459** for 3196, 3197
 CLIP TYPE LEAD WITH TEMPERATURE SENSOR **9460** for 3550, 3551, 3551-03
 PIN TYPE LEAD **9461** for 3155*, 3555, 3540
 THERMISTOR TEMPERATURE PROBE **9462** for 3281*, 3282, 3282-01
 HUMIDITY SENSOR **9463** for 3625*
 HUMIDITY SENSOR **9464** for 3625*
 PIN TYPE LEAD **9465** for 3550, 3551, 3552, 3555, 3540
 PIN TYPE LEAD **9465-10** for 3554
 REMOTE CONTROL SWITCH **9466** for 3551, 9465
 LARGE CLIP TYPE LEAD **9467** for 3550, 3226*, 3227*
 SHEATH TYPE TEMPERATURE PROBE **9472** for 3441, -01, -02, 3442-02, -03, 7015*
 SHEATH TYPE TEMPERATURE PROBE **9472-50** for 3446 (K)
 SHEATH TYPE TEMPERATURE PROBE **9473** for 3441, -01, -02, 3442-02, -03, 7015*
 SHEATH TYPE TEMPERATURE PROBE **9473-50** for 3446 (K)
 SHEATH TYPE TEMPERATURE PROBE **9474** for 3441, -01, -02, 3442-02, -03, 7015* (K)
 SHEATH TYPE TEMPERATURE PROBE **9475** for 3441, -01, -02, 3442-02, -03, 7015* (K)
 SURFACE TYPE TEMPERATURE PROBE **9476** for 3441, -01, -02, 3442-02, -03, 7015* (K)
 SURFACE TYPE TEMPERATURE PROBE **9476-50** for 3446 (K)
 SHEATH TYPE TEMPERATURE PROBE **9478** for 3447 (PT-100)
 SHEATH TYPE TEMPERATURE PROBE **9479** for 3447 (PT-100 with switch)
 4 TERMINAL PROBE **9500** for LCR
 GP-IB INTERFACE **9517** for 3186, 3227*
 GP-IB INTERFACE **9518-01** for 3511, 3531*, 3532
 GP-IB INTERFACE **9518-02** for 3157, 3157-01
 FUNCTION UP DISK **9540-01** for 8835-01
 FUNCTION UP DISK(POWER MONITOR) **9549** for 8855
 SENSOR UNIT **9555-50** for 9272-10, 9277, 9278, 9279
 RS-232C CARD **9557** for MEMORY HiCORDER
 GP-IB CARD **9558** for MEMORY HiCORDER
 INPUT CORD **9574** for 8944(8851)*
 GP-IB INTERFACE **9588** for 3227*, 3167*, 3187*, 3330*, 3330-02*
 PRINTER INTERFACE **9589** for 3227*, 3560
 RS-232C INTERFACE **9593-01** for 3522, 3531*, 3532
 RS-232C INTERFACE **9593-02** for 3157, 3157-01
 MO UNIT **9598** for 8826
 MEMORY BOARD **9599** for 8826 (48M-word)
 AC/DC DIRECT INPUT UNIT **9600** for 3193
 AC DIRECT INPUT UNIT **9601** for 3193

AC/DC CLAMP INPUT UNIT **9602** for 3193
 EXTERNAL SIGNAL INPUT UNIT **9603** for 3193
9603-01 EXTERNAL SIGNAL INPUT UNIT for 3194
 PRINTER UNIT **9604** for 3193
 HARMONIC/FLICKER MEASUREMENTS UNIT **9605** for 3193
 HARMONIC MEASUREMENTS UNIT **9605-01** for 3194
 MO UNIT **9607** for 8841, 8842
 MEMORY BOARD(24M-WORD) **9608** for 8841, 8842
 RS-232C CABLE **9612** for DIN 9pin-Dsub 9pin 8807, 8808, 8420
 REMOTE CONTROL BOX(SINGLE) **9613** for 3158, 3159
 REMOTE CONTROL BOX(DUAL) **9614** for 3158, 3159
 H.V.TEST LEAD **9615** for 3158, 3159
 H.V.TEST LEAD **9615-01** for 3931 Red (High Voltage)
 H.V. TEST LEAD **9615-03** for 3931 Black (Return)
 WARNING LAMP **9616** for 3158, 3159
 CLIP ON BASE **9617** for 3501, 3801, 3802, 3804, 3805
 CLIP-TYPE LEAD **9618** for 3501, 3801, 3802, 3804, 3805
 POWER ANALYZER **9623** for 3193
 POA-HIVIEW **9624** for 3196
 POA-HIVIEW PRO **9624-10, -50** for 3196, 3197
 POWER MEASUREMENT SUPPORT SOFTWARE **9625** for 3166*, 3169
 LAN CABLE **9628** for 3660
 CONNECTION CABLE **9629** for 3639
 TEMPERATURE SENSOR **9631-01** for 3641 (1m)
 TEMPERATURE SENSOR **9631-02** for 3641 (1m)
 TEMPERATURE SENSOR **9631-03** for 3641 (1m)
 TEMPERATURE SENSOR **9631-04** for 3641 (1m)
 TEMPERATURE SENSOR **9631-05** for 3641 (30 mm)
 TEMPERATURE SENSOR (9631-01,5m) **9631-11** for 3641 (5 m)
 TEMPERATURE SENSOR (9631-04,5m) **9631-14** for 3641 (5 m)
 TEMPERATURE SENSOR (9631-01,10m) **9631-21** for 3641 (10 m)
 TEMPERATURE SENSOR (9631-04,10m) **9631-24** for 3641 (10 m)
 CONNECTION CABLE **9632** for 3634, 3635-04-06, 3635-24-26, 3636
 CONNECTION CABLE **9633** for 3634, 3635
 CONNECTION CABLE **9634** for 3630, 3635-01,02
 VOLTAGE CORD **9635** for 3286
 RS-232C CABLE **9636** for 3286
 RS-232C PACKAGE **9636-01** for 3286
 RS-232C CABLE (9pin-9pin/1.8m) **9637** for 3154, 3630S, 3911-20
 RS-232C CABLE (9pin-25pin/1.8m) **9638** for 3154, 3630S, 3911-20
 CONNECTION CABLE **9639** for 3637
 CONNECTION CABLE **9641** for 8420
 LAN CABLE **9642** for 8420
 CHARGE STAND **9643** for 8420
 SCSI INTERFACE **9644** for 8855
 MEMORY BOARD **9645** for 8855
 MEMORY BOARD **9645-01** for 8855
 MO UNIT **9646** for 8855
 CARRYING CASE **9648** for 8807, 8808, 8420, 8421, 8714*, 8715
 PROTECTIVE CASE **9649** for 8807, 8808, 8420, 8421
 CLAMP ON SENSOR **9650** for 100A 8205, 8206, 3636-20
 CLAMP ON SENSOR **9651** for 500A 8205*, 8206*, 3636-20
 FIXED STAND **9652** for 8807, 8808, 8420, 8421
 FIXED STAND **9652-01** for 8420-50, 8421-50, 8422-50, 8807, 8808
 HUMIDITY SENSOR **9653** for 8420, 8421
 CLAMP ON LEAK SENSOR **9657** for 3638
 CLAMP ON LEAK SENSOR **9657-10** for 8808series (BNC)

CLAMP ON LEAK SENSOR **9658** for 3638
 CLAMP ON SENSOR **9660** for 3196 AC100A, 3197
 CLAMP ON SENSOR **9661** for 3196 AC500A, 3197
 LUX SENSOR **9662** for 3640
 HD UNIT **9663** for 8855
 10:1 PROBE **9665** for MEMORY HiCORDER
 100:1 PROBE **9666** for MEMORY HiCORDER
 FLEXIBLE CLAMP ON SENSOR **9667** for 3196 AC5000A, 3197
 CLAMP ON SENSOR **9668** for 8205-10/8206-10 AC1000A
 CLAMP ON SENSOR **9669** for 3196 AC1000A, 3197
 PRINTER **9670** for 3196, 3446/47, 3197
 AC ADAPTER **9671** for 9670
 RS-232C PACKAGE **9674** for 3446/47
 SMD TEST FIXTURE **9677** for 3511
 CONNECTION CABLE **9678** for 3535
 CONNECTION CABLE **9679** for 3503
 HUMIDITY SENSOR **9680-50** for 3641 (1m)
 HUMIDITY SENSOR **9680-51** for 3641 (5m)
 HUMIDITY SENSOR **9680-52** for 3641 (10m)
 HUMIDITY SENSOR **9681** for 8420s
 DC POWER UNIT **9684** for 8860-50, 8861-50
 CARRYING CASE **9685** for 3246
 CARRYING CASE **9686** for 3156
 CLAMP ON AC/DC SENSOR **9691** for 3290 AC100A
 CLAMP ON AC/DC SENSOR **9692** for 3290 AC200A
 CLAMP ON AC/DC SENSOR **9693** for 3290 AC2000A
 CLAMP ON SENSOR **9694** for 3169, 3196, 3197, AC5A
 SMD TEST FIXTURE **9699** for 3511
 HEAD AMP UNIT **9700-10** for 3535
 CONVERSION ADAPTER **9704** for 9010-50, 9018-50
 AC/DC CURRENT SENSOR **9709** for 3193
 CAN CABLE **9713-02** for 8910
 LOGIC CABLE **9714-01** for 8910
 MEMORY BOARD **9715-50, -51, -52, -53** for 8860-50, 8861-50
 HD UNIT **9718-50** for 8860-50, 8861-50
 MEMORY BUCK UP UNIT **9719-50** for 8860-50, 8861-50
 LOGIC CABLE **9714-02** for 8910
 CARRYING CASE **9720** for 3169
 RS-232C CABLE **9721** for 3169
 PC CARD 128M **9726** for 8800S, 3169, 3196
 PC CARD 256M **9727** for 8800S, 3169, 3196
 PC CARD 512M **9728** for 8800S, 3169, 3196
 PC CARD 1GB **9729** for 8800S
 CARRYING CASE **9730** for 3661, 3662, 3663
 FC CONNECTOR ADAPTER **9731** for 3661
 SC CONNECTOR ADAPTER **9732** for 3661
 FC CONNECTOR ADAPTER **9733** for 3662, 3663
 SC CONNECTOR ADAPTER **9734** 3662, 3663
 FC-FC OPTICAL FIBER CABLE **9735** for 3661, 3662, 3663
 SC-SC OPTICAL FIBER CABLE **9736** for 3661, 3662, 3663
 SC-FC OPTICAL FIBER CABLE **9737** for 3661, 3662, 3663
 OPTICAL CONNECTOR CLEANER **9738** for 3661, 3662, 3663
 SPARE CLEANER **9739** for 3661, 3662, 3663
 OPTICAL SENSOR **9742, -01** for 3664
 TEST TYPE LEAD **9750** for 3455
 ALLIGATOR CLIP **9751** for 3455
 PIN-TYPE LEAD **9770** for 3239, 3540, 3541, 3555, 3560, 3561
 PIN-TYPE LEAD **9771** for 3239, 3540, 3541, 3555, 3560, 3561
 PIN TYPE LEAD **9772** for 3554
 LINE SPLITTER **CT-101A** for 3127-11 etc.
 PAPER WINDER **220H** TEPTOM-220H
 ALLIGATOR CLIPS 9170 or similar devices (used with Test Lead, inserted)

HIOKI - Offering Top Quality Products and Services

HIOKI E.E. CORPORATION TRACEABILITY CHART

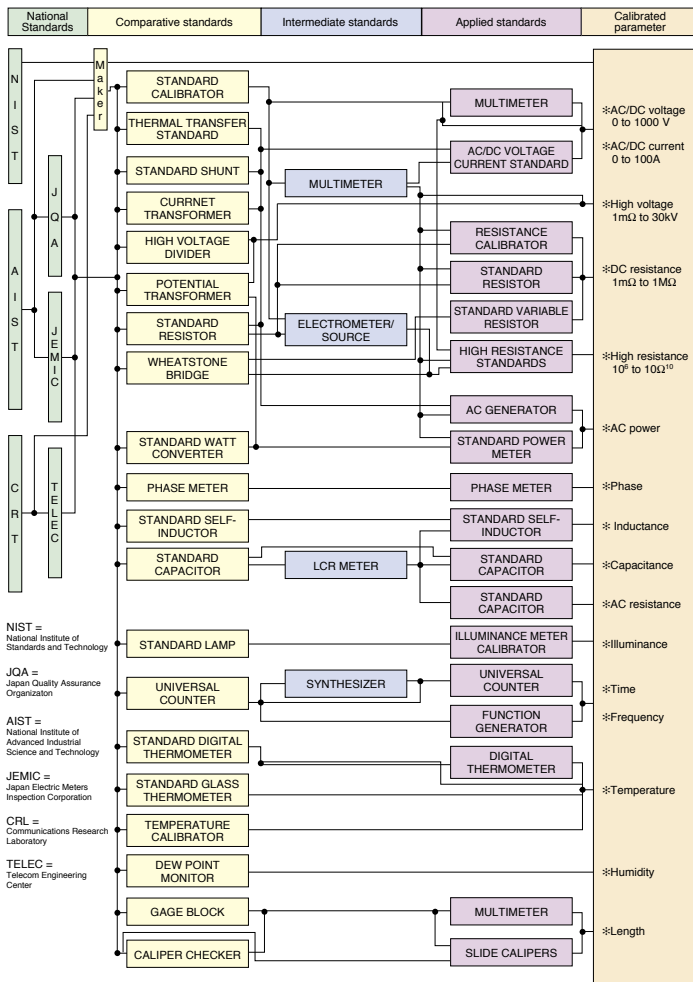

Note: Only the primary standards are indicated above. For details, please refer each product's TRACEABILITY CHART. Please also note that the naming of the standards indicated in this chart may differ from the naming used in each product's TRACEABILITY CHART.

Accuracy can be regarded as the heart of a measuring instrument. To maintain accuracy, traceability and accountability in the form of a coherent and comprehensive management system that reaches to the national standards are indispensable.

Traceability allows us to manage and maintain instrument accuracy characteristics that are tied to recognized national and international standards. How they are managed and maintained are dependent on the measurement facilities that offer accuracy testing at the various levels, skilled technicians, as well as a strong link between national standards, manufacturer reference equipment, field measuring instruments, and basic measuring instruments.

The HIOKI Traceability System as indicated by the chart on the left is strictly managed by accounting for each individual instrument - from reference instruments to field equipment - and their constant accuracy. As scientific techniques and manufacturing technology continue to expand and develop, we will strive to meet new demands by not only providing the appropriate measuring instruments for our users, but also enhancing the accuracy in our test instruments and maintaining our Traceability System so that they are constantly on par with global standards.

HIOKI's Calibration System

In order to provide dependable and quality-assured products, HIOKI has acquired the international standard ISO/IEC17025 certification for calibration, which allows us to meet a wide variety of calibration needs. By regularly calibrating HIOKI instruments using reference calibrating equipment traceable to national standards while complying with the reference equipment organizational chart, customers are guaranteed complete accuracy. After purchase, it is highly recommended that customers regularly re-calibrate their HIOKI instruments to maintain their accuracy. Depending on your needs, calibration and adjustment can be conducted at HIOKI in one of 4 ways as illustrated on the right.

Types of Calibration

Type	Action	Price
Type 1	The relationship between the measurement values of the instrument being serviced and those of the reference and testing instruments placed in the higher order in the calibration flow are observed and the results are recorded in a data sheet. (If the measurement values fall outside of the specifications for accuracy, these values are not indicated.) 	Calibration + Data Sheet
Type 2	The relationship between the measurement values of the instrument being serviced and those of the reference and testing instruments placed in the higher order in the calibration flow are observed and the results are recorded in a data sheet. The instrument is then adjusted, and once again compared to the same reference and testing instruments, and the results are recorded in a separate data sheet. 	Calibration + Adjustment + 2 Data Sheet
Type 3	The relationship between the measurement values of the instrument being serviced and those of the reference and testing instruments placed in the higher order in the calibration flow are observed and the results are recorded in a data sheet. If the values are within the specifications for accuracy, calibration is completed. If the values fall outside of the specifications, the instrument is then adjusted, compared again to the same reference and testing instruments, and the results are recorded in a separate data sheet. 	Calibration + Data Sheet Calibration + Adjustment + 2 Data Sheet
Type 4	Whether or not the instrument's measurement values fall within the specifications for accuracy, it is first adjusted, and then compared to the values of the reference and testing instruments placed in the higher order of the calibration flow. The results are then recorded in a data sheet. 	Calibration + Adjustment + Data Sheet

About our Company



Established in 1935, HIOKI E. E. CORPORATION has grown to be a leading developer and manufacturer of advanced test and measurement technologies for use both in the field and leading edge facilities around the world. Our goal is simple: contribute to the advancement of society, while making sure the natural environment is not compromised. As a reliable producer and member of society, we pledge to continue to actively contribute to the cultural and educational development of the local community through activities such as greening efforts, scholarship programs and sponsoring children's sports teams. With the support of our customers and worldwide network, we are confident that our values and beliefs, and products and services, will be brought forth through the 21st century and beyond.

Internet website



www.hioki.com

Corporate History

- 1935 HIOKI starts manufacturing electrical measuring instruments in Tokyo
- 1945 Move to Nagano Prefecture due to war
- 1946 Tester No.1 put to market
- 1952 HIOKI E.E. CORPORATION established
Designated as the manufacturer of MULTITESTER (MIL Standard) for the U.S. Far East Air Forces
- 1965 Mass production of VU instruments for recording level adjustments to tape recorders
- 1975 Independent development and sale of instruments with internal magnetic taut bands
- 1983 Multiple awards received for innovative clamp-style instruments
- 1990 Move to HIOKI Forest Hills
- 1991 Registered on the over-the-counter market
- 1992 Awarded the Afforestation Center Presidential Award for positively promoting afforestation
- 1993 ISO9001 certified
- 1997 ISO14001 certified
- 1998 HIOKI USA CORPORATION established
- 2001 HIOKI Shanghai Representative Office established
Listed on the Second Section of the Tokyo Stock Exchange
- 2003 Listed on the First Section of the Tokyo Stock Exchange
- 2005 "Solution Fair" - 70th Anniversary Celebration
- 2006 THT Technology Joint Venture in Taiwan established
HIOKI Tianjin Representative Office established
"Solution Factory" Building B Completed
Electronic Measuring Instruments Business Segment of DKK-TOA Corporation acquired
HiNSTEC Corporation established





HIOKI

HIOKI E. E. CORPORATION

HEAD OFFICE :

81 Koizumi, Ueda, Nagano, 386-1192, Japan
TEL +81-268-28-0562 / FAX +81-268-28-0568
E-mail: os-com@hioki.co.jp

HIOKI USA CORPORATION :

6 Corporate Drive, Cranbury, NJ 08512 USA
TEL +1-609-409-9109 / FAX +1-609-409-9108
E-mail: hioki@hiokiusa.com

HIOKI (Shanghai) Sales & Trading Co., Ltd. :

1904 Shanghai Times Square Office, 93 Huai Hai Zhong Road
Shanghai, P.R.China POSTCODE: 200021
TEL +86-21-6391-0090/0092 FAX +86-21-6391-0360
E-mail: info-sh@hioki.cn

Beijing Office :

A-2602 Freetown, 58 Dong San Huan Nan Road
Beijing, P.R.China POSTCODE: 100022
TEL +86-10-5867-4080/4081 FAX +86-10-5867-4090
E-mail: info-bj@hioki.cn

Guangzhou Office :

Room 303, Profit Plaza, No.76, West Huangpu Road
Guangzhou, P.R.China POSTCODE: 510623
TEL +86-20-38392673/2676 FAX +86-20-38392679
E-mail: info-gz@hioki.cn

DISTRIBUTED BY

All information correct as of April 30, 2008. All specifications are subject to change without notice.



This brochure has been printed on recycled paper
with special ink blended with recycled soy oil.